

Chikkanna Government Arts College

Tiruppur – 641 602

5.3.2 : Information Brochure of Sports and Cultural Events participated 2018-2021

(Page No. 2-24)

Participation Abstract 2018-2023

(Page No. 25-29)

Participation Certificates

(Page No 29-126)

അദ്ധ്യക്ഷൻ

23/9/19

ശ്രീ. ഇന്ദുഗൗരവ്

മേൽപ്പറഞ്ഞ കോർപ്പറേഷൻ

പിൻപുറംഗത്ത് സ്ഥലം കോർപ്പറേഷൻ കമ്മിറ്റിയിൽ
കീഴെപ്പറയുന്ന വിധത്തിൽ.

അദ്ധ്യക്ഷൻ

ശ്രീ. വിജയ് എസ്. വിജയ്

പിൻപുറംഗത്ത് സ്ഥലം കോർപ്പറേഷൻ കമ്മിറ്റിയിൽ
കീഴെപ്പറയുന്ന വിധത്തിൽ.

അദ്ധ്യക്ഷൻ

അവതരണം :- മേൽപ്പറഞ്ഞ കമ്മിറ്റിയിൽ
സ്ഥലം കോർപ്പറേഷൻ കമ്മിറ്റിയിൽ.

അദ്ധ്യക്ഷൻ വിജയ് എസ്. വിജയ്

അദ്ധ്യക്ഷൻ വിജയ് എസ്. വിജയ്
23/9/19
23.09.19
കീഴെപ്പറയുന്ന വിധത്തിൽ.
R.V. കോർപ്പറേഷൻ കമ്മിറ്റിയിൽ
അദ്ധ്യക്ഷൻ വിജയ് എസ്. വിജയ്
കീഴെപ്പറയുന്ന വിധത്തിൽ.
അദ്ധ്യക്ഷൻ വിജയ് എസ്. വിജയ്

23.09.19

കീഴെപ്പറയുന്ന വിധത്തിൽ.

അദ്ധ്യക്ഷൻ

ശ്രീ. ഇന്ദുഗൗരവ്
23/09/19

23/9/19

CHIKKANNA GOVERNMENT ARTS COLLEGE, Tirupur
DEPARTMENT PHYSICAL EDUCATION

VOUCHERS FOR TA & DA

Name of the Competition : Bharathiyas University Hockey Meet
 Date of the Competition : 03.09.2019 to 05.09.2019.
 Venue of the Competition : KCT Arts College, Coimbatore.

S.No.	Name of the Students	Class	TA (To & Fro)	DA 3 1/2 days	Total	Signature
1.	Devakumar V.	I. B.Sc Physics	140	437	577	V. Devakumar
2.	Growtham S.	II. B.Com CA	140	437	577	S. Growtham
3.	Agathiyan S.	II. B.Sc Maths	140	437	577	S. Agathiyan
4.	Kulanthavel N.	II. BA history	140	437	577	N. K.H.I.
5.	Kaviyarsu S.	II. BA history	140	437	577	S. Kaviyarsu
6.	Growtham K.	II. BA history	140	437	577	K. Growtham
7.	Jesra S.	II. BA history	140	437	577	S. Jesra
8.	Ravikaran M.	II. BA history	140	437	577	M. Ravikaran
9.	Jagatheswaran V.	I. B.Sc CS	140	437	577	V. Jagatheswaran
10.	Vijayan	III. BA English	140	437	577	Vijayan
11.	Saravanan Kumar A.	I. BA history	140	437	577	A. Saravanan
12.	Elam Parithi E.	I. BA history	140	437	577	E. Parithi
13.	GOPALA KRISHNAN	III. B.Sc zoology	140	437	577	G. Krishnan
14.	Mohanraj R.	III. B.Com IB	140	437	577	R. Mohanraj
15.	MAHENDRAN	I. M.Sc CS	140	437	577	M. Mahendran
16.	T. RAJARAM.	PD	140	375	515	T. Rajaram
					9170/-	
					9170/-	

PRINCIPAL



PHYSICAL DIRECTOR
 Director of Physical Education
 Chikkanna Govt. Arts College
 Tirupur - 641 602.

BHARATHIAR UNIVERSITY, COIMBATORE - 641 046

Inter - Collegiate Kabaddi B - Zone Tournament for Men 2019 - 2020

Venue	Sri Ramalinga Sowdambigai College, Coimbatore - 641 109.
Date	30.09.2019 to 01.10.2019
Convener	Mr. R. Jeyith Mobile NO: 8608605745

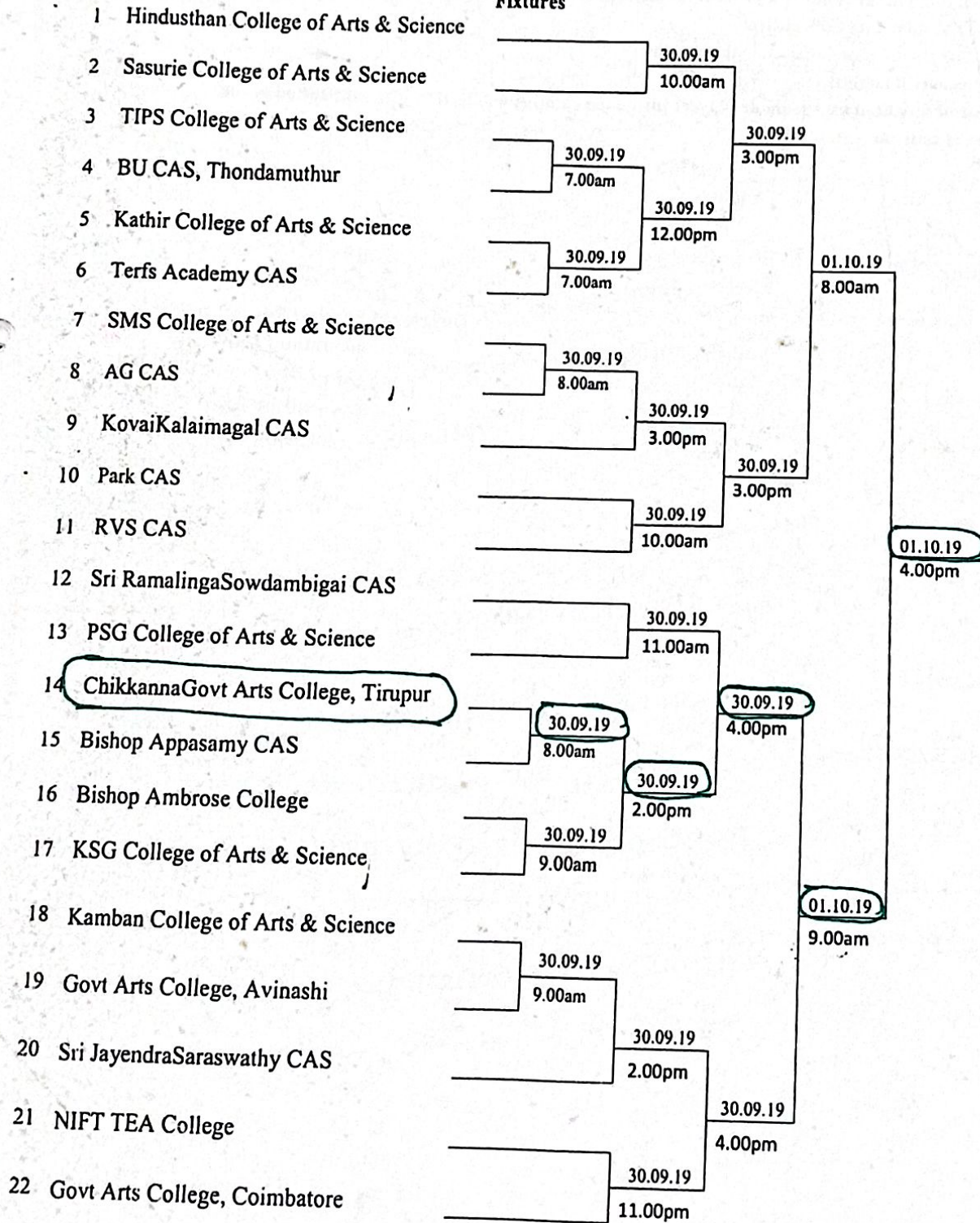
Fixtures



• Third & Fourth Match will be conducted on 01.10.2019 at 2.00pm

[Handwritten Signature]

Director of Physical Education i/c
Bharathiar University,
Coimbatore - 641 046.

[Handwritten mark]

Instructions:

1. The team should report 30 minutes before the scheduled time
2. Rs. 500/- has to be deposited to the convener, as caution deposit which will be refunded to the team manager at the time of check out with deductions if any, respect of damage etc.
3. The trophy holders should bring the trophy and hand it over to the convener without fail.
4. Teams should bring the eligibility details in the prescribed form duly attested by the Principal and Director of Physical Education with College Seal
5. Strict discipline should be maintained in the campus.
6. Official decision will be final.
7. Misbehavior of any kind by a team or players inside the campus will lead to disqualification of the team from the tournament.

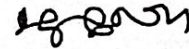

Director of Physical Education i/c
Bharathiar University
Director of Physical Education i/c
Bharathiar University,
Coimbatore - 641 046.

அனுப்பிகள்:

தி. சிவசுந்தரன்

IIIrd B.Sc Physics

சீக்கண்டிணா அரசு கலைக் கல்லூரி
திருப்பிகர் - 641602.

பெறுதல்:

இயற்பியல் துறைத் தலைவர் அவர்கள்,
சீக்கண்டிணா அரசு கலைக் கல்லூரி,
திருப்பிகர் - 641602.

ஆயா,

பெறுதல்: லாபீஸ்மென்ட் அபிவிருத்தி சார்பாக,

ஆயா. நான் சீக்கண்டிணா இயற்பியல்
துறையால் பயணித்து வருகிறேன். நடந்த லாபீஸ்
நடந்த காலத்தில் அனைவரின் உற்சாகம்
மேலேயும் நான் செய்து கொண்டிருப்பேன்,
லாபீஸ் அனைவரின் உற்சாகம் மேலேயும்
கொண்டு கொண்டிருக்கிறேன், (கொண்டு மேலேயும்)
கொண்டு லாபீஸ்மென்ட் அபிவிருத்தி துறை
நாளைக்காலம் காலகாலத்திற்கும்.

மேலே காலகாலம் நான்:

15 ~~10~~ - 11 - 2021

28 - 11 - 2021

10/11/21
G. S. S.

உரை.
துறைத் தலைவர் அவர்கள்:

அபிவிருத்தி, உரை
V. S. S.
12/11/21

அறிவிப்பு :

T. வெங்கடேஸ்வரன் மாறு,

01/28/11/2026

I. B. Sc chemistry,

சீக்கிரவாணியா அரசு கலைக்கல்லூரி,
கடலூர்.

பெயர் :

சீக்கிரவாணியா அரசு கலைக்கல்லூரி,

கடலூர்.

பெயர் :

சீக்கிரவாணியா அரசு கலைக்கல்லூரி

கலைக்கல்லூரி கல்விக்கான அமைச்சர்
அலுவலகம், கடைக்கலை.

ஆக,

சீக்கிரவாணியா அரசு கலைக்கல்லூரி

கலைக்கல்லூரி

கலைக்கல்லூரி

கலைக்கல்லூரி

கலைக்கல்லூரி

கலைக்கல்லூரி

கலைக்கல்லூரி

கலைக்கல்லூரி

கலைக்கல்லூரி

கலைக்கல்லூரி

கலைக்கல்லூரி

கலைக்கல்லூரி

கலைக்கல்லூரி

கலைக்கல்லூரி

கலைக்கல்லூரி

கலைக்கல்லூரி

கலைக்கல்லூரி

கலைக்கல்லூரி

கலைக்கல்லூரி

கலைக்கல்லூரி

கலைக்கல்லூரி

கலைக்கல்லூரி

கலைக்கல்லூரி

கலைக்கல்லூரி

சீக்கிரவாணியா அரசு கலைக்கல்லூரி
01/28/11/2026

Respected Principal
S. Aranganathan

Director of Physical Education
Sikkanna Government Arts College
Tirupur - 641 602.

சீக்கிரவாணியா அரசு கலைக்கல்லூரி

சமூகப்பணம்

சு. கந்தசாமி

B.Sc. [CDF] 1 Year

விக்கலாசா அரங்கக் கலைக்கல்லியம்,
சூரியபுரம்.

47
20/1/2020

பெயர்:

கல்லியம் சூரியபுரம் அரங்கம்
விக்கலாசா அரங்கக் கலைக்கல்லியம்,
சூரியபுரம்.

தமிழ்நாடு அணி:

பெயர்:

31th TAMILNADU STATE SUB-JUNIOR
KABADDI CHAMPIONSHIP.

KABADDI

கலைக்கலை கல்விக்கலை பல்விக்கலை கல்விக்கலை
கலைக்கலை கல்விக்கலை பல்விக்கலை கல்விக்கலை
22/12/19 கலைக்கலை 13/01/2020 கலைக்கலை கலைக்கலை

கலைக்கலை கலைக்கலை கலைக்கலை கலைக்கலை கலைக்கலை
கலைக்கலை கலைக்கலை கலைக்கலை கலைக்கலை கலைக்கலை

கலைக்கலை கலைக்கலை கலைக்கலை கலைக்கலை கலைக்கலை
கலைக்கலை கலைக்கலை கலைக்கலை கலைக்கலை கலைக்கலை

கலைக்கலை கலைக்கலை கலைக்கலை கலைக்கலை கலைக்கலை
கலைக்கலை கலைக்கலை கலைக்கலை கலைக்கலை கலைக்கலை

கலைக்கலை கலைக்கலை கலைக்கலை கலைக்கலை கலைக்கலை
கலைக்கலை கலைக்கலை கலைக்கலை கலைக்கலை கலைக்கலை

Forwarded to
Respected Principal

20/01/2020
Director of Technical Education
Chikkanna Chinnai College
Tamil Nadu - 641 662.

சு. கந்தசாமி
T. KoundharSamy.

BHARATHIAR UNIVERSITY :: COIMBATOR - 641 046
DEPARTMENT OF PHYSICAL EDUCATION
BHARATHIAR UNIVERSITY 38th INTER - COLLEGIATE ATHLETIC MEET 2019 - 2020

ENTRY FORM FOR MEN ONLY CHIKKANNI GOVT ARTS COLLEGE, Tirupur.

Chest No	SL No	Name of the Athlete	100 M	200 M	400 M	800 M	1500 M	5,000 M	10,000 M	110 MH	400 MH	Long Jump	High Jump	Triple Jump	Pole vault	Shot-put	Hammer Throw	Javelin Throw	Discus Throw	Decathlon	4 x 100 M Relay	4 x 400 M Relay	20 KM Walk	Half Marathon	
	1	V. AJITH KUMAR																							
	2																								
	3																								
	4																								
	5																								
	6																								
	7																								
	8																								
	9																								
	10																								
	11																								
	12																								

- > Please use 'C' letter for Competitor and 'R' letter for Reserve with separate colour, Chest number column is reserved for organizer's use.
- > A Competitor is allowed to participate, not more than two events other than relay race.

[Signature]
 Director of Physical Education
 Chikkanna Govt. Arts College
 Tirupur - 641 602.



[Signature]
 Principal
PRINCIPAL
 Chikkanna Govt. Arts College
 Tirupur

From

T.Rajaram
Director of Physical Education,
Chikkanna Govt Arts College,
Tirupur.

To

Director of Physical Education (i/c)
Bharathiyar University,
Coimbatore.

Dear Sir,

Sub: - Sports Entry Form – reg.

With great pleasure, I have attached our college sports entry form for the academic year 2019 – 2020. Kindly accept our college entry and make our college team to participate in Bharathiyar University inter collegiate sports and games (2019 – 2020).

Thank you

Yours

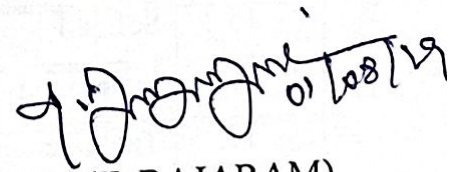
(T. RAJARAM)

Director of Physical Education
Chikkanna Govt. Arts College
Tirupur - 641 602.

BHARTHIYAR UNIVERSITY, COIMBATORE - 641046
DEPARTMENT OF PHYSICAL EDUCATION
INTER COLLEGIATE TOURNAMENTS
ENTRY FORM 2019 - 2020

Name of the College: **CHIKKANNA GOVT ARTS COLLEGE, Tirupur.**

S.NO	GAME	MEN	WOMEN
1.	Badminton		
2.	Ball Badminton		
3.	Basketball		
4.	Best Physique	✓	
5.	Boxing	✓	
6.	Chess	✓	
7.	Cricket - B Zone	✓	
8.	Cross Country	✓	
9.	Football - B Zone	✓	
10.	Handball		
11.	Hockey	✓	
12.	Kabaddi - B Zone	✓	
13.	Kho - Kho.		
14.	Power Lifting		✓
15.	Softball		
16.	Swimming		
17.	Table Tennis		
18.	Taekwondo	✓	
19.	Tennis		
20.	Volleyball - B Zone	✓	
21.	Weight Lifting		✓

[Signature]
 Signature of the Director of
 Physical Education

Director of Physical Education
Chikkanna Govt. Arts College
Tirupur - 641 602.

[Signature]
 Principal

PRINCIPAL
Chikkanna Govt. Arts College
Tirupur

എഴുത്തുകാരന്

ടി. ജയചന്ദ്രൻ

മലയാളത്തിൽ എഴുതുന്ന
എൻ. കെ. ജോർജ്ജ്
എന്ന പേരിൽ.

എഴുത്തുകാരന്

എൻ. കെ. ജോർജ്ജ്
എൻ. കെ. ജോർജ്ജ്
എന്ന പേരിൽ.

എൻ. കെ. ജോർജ്ജ്

എൻ. കെ. ജോർജ്ജ് :- മനോരമ, കമ്മ്യൂണിക്
എൻ. കെ. ജോർജ്ജ് ജനറലിസ്റ്റ്-ട്രിപ്പി
എൻ. കെ. ജോർജ്ജ് പബ്ലിഷിംഗ് കമ്പനി

എൻ. കെ. ജോർജ്ജ് പബ്ലിഷിംഗ് കമ്പനി (20, 23 & 25
Sep 2019) കമ്പ്യൂട്ടർ സോഫ്റ്റ്‌വെയർ (30.09.19 &
01.10.19) ഇതര പേജ്‌വർക്ക് പേജ്‌വർക്ക് പേജ്‌വർക്ക്

എൻ. കെ. ജോർജ്ജ് പബ്ലിഷിംഗ് കമ്പനി കമ്പ്യൂട്ടർ സോഫ്റ്റ്‌വെയർ
- ഇൻ. ടി. കെ. ജോർജ്ജ് പബ്ലിഷിംഗ് കമ്പനി പേജ്‌വർക്ക് പേജ്‌വർക്ക്
എൻ. കെ. ജോർജ്ജ് പബ്ലിഷിംഗ് കമ്പനി പേജ്‌വർക്ക് പേജ്‌വർക്ക് പേജ്‌വർക്ക്
എൻ. കെ. ജോർജ്ജ് പബ്ലിഷിംഗ് കമ്പനി പേജ്‌വർക്ക് പേജ്‌വർക്ക് പേജ്‌വർക്ക്
എൻ. കെ. ജോർജ്ജ് പബ്ലിഷിംഗ് കമ്പനി പേജ്‌വർക്ക് പേജ്‌വർക്ക് പേജ്‌വർക്ക്
എൻ. കെ. ജോർജ്ജ് പബ്ലിഷിംഗ് കമ്പനി പേജ്‌വർക്ക് പേജ്‌വർക്ക് പേജ്‌വർക്ക്

എൻ. കെ. ജോർജ്ജ് പബ്ലിഷിംഗ് കമ്പനി പേജ്‌വർക്ക് പേജ്‌വർക്ക് = ₹ 3600/-
എൻ. കെ. ജോർജ്ജ് പബ്ലിഷിംഗ് കമ്പനി പേജ്‌വർക്ക് പേജ്‌വർക്ക് = ₹ 4200/-

എൻ. കെ. ജോർജ്ജ്
18/10/19.

എൻ. കെ. ജോർജ്ജ്
18/10/19

CHIKKANNA GOVERNMENT ARTS COLLEGE, Tirupur
DEPARTMENT PHYSICAL EDUCATION

VOUCHERS FOR TA & DA

Name of the Competition : Bharathidasan University Karandalehi Mats
 Date of the Competition : 30.09.19 to 01.10.19
 Venue of the Competition : S.R.S Arts College, Thoncharintheer.

S.No	Name of the Students	Class	TA (To & fro)	DA (2 days)	Total	Signature
1	C. AJITHKUMAR	IMSC (Phy)	140	250	390	C. Ajithkumar
2	K. NARENDRA	II B.com	140	250	390	K. Narendran
3	M. SASTI	I B. ARD	140	250	390	m. Sasti
4	S. SUBASH	II BCA	140	250	390	S. Subash
5	S. MANOJ	I BCOM	140	250	390	Manoj
6	K. SURYA PRAKASH	IMSC Maths	140	250	390	K. Surya
7	R. SURYA	I BCOM	140	250	390	R. Surya
8	A. ARUN	II BCOM	140	250	390	A. Arun
9	T. KANIHASAMY	I B.Sc. CDE	140	250	390	T. Kanthasamy
10	E. RAJKUMAR	I B.Sc. B.A.T	140	250	390	E. Rajkumar
11	A. Jaiulabdeen	II B.C. CDE	140	250	390	A. Jaiulabdeen
12	G. SANTIHOSH	II B.Sc. CDE	140	250	390	G. Santhosh
13	T. RAJARAM	PD	280	250	530	T. Rajaram
		Total.	-	-	5210	
	(five thousand - two hundred and Ten Only)					

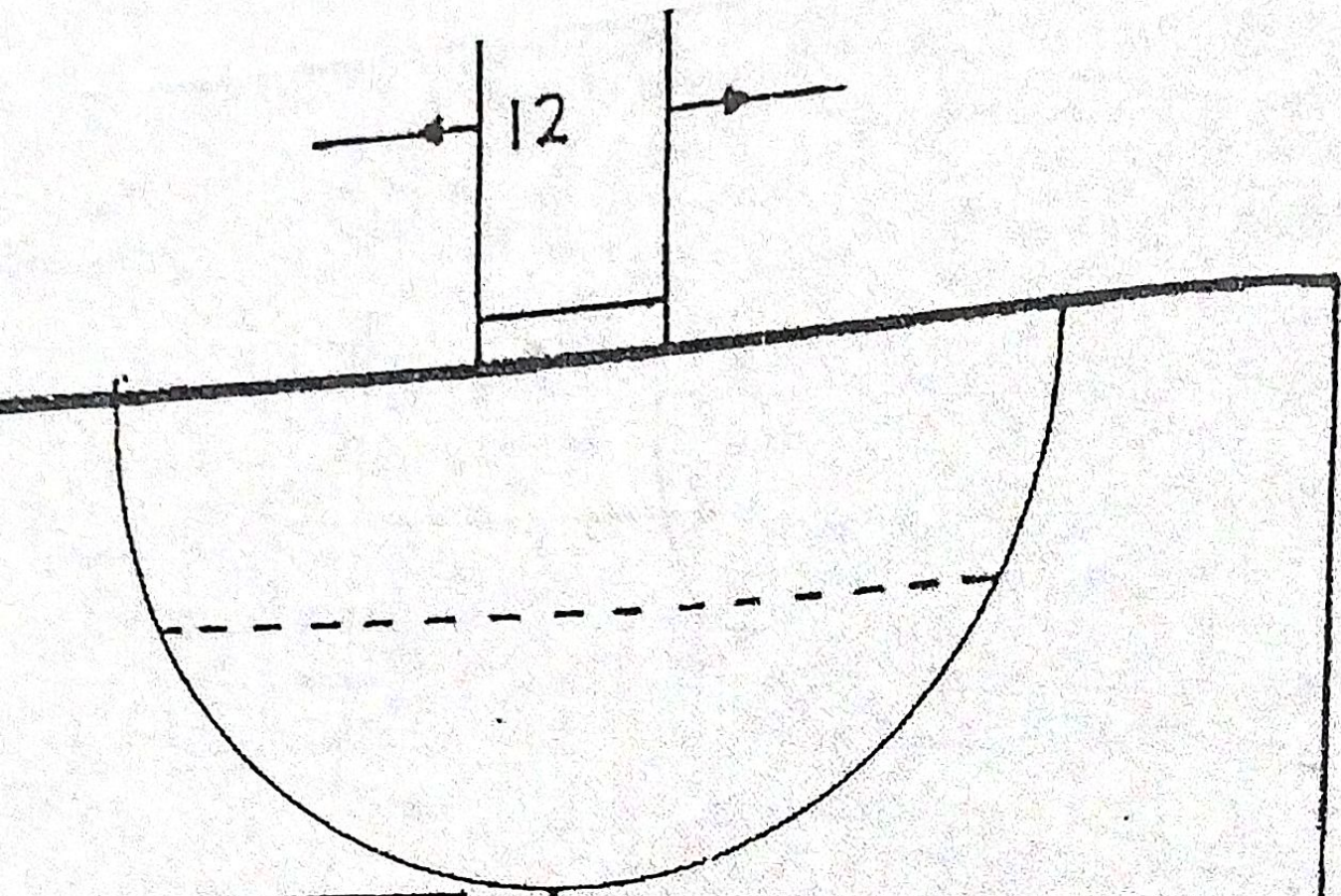

 18/10/19
PRINCIPAL

 18/10/19
PHYSICAL DIRECTOR

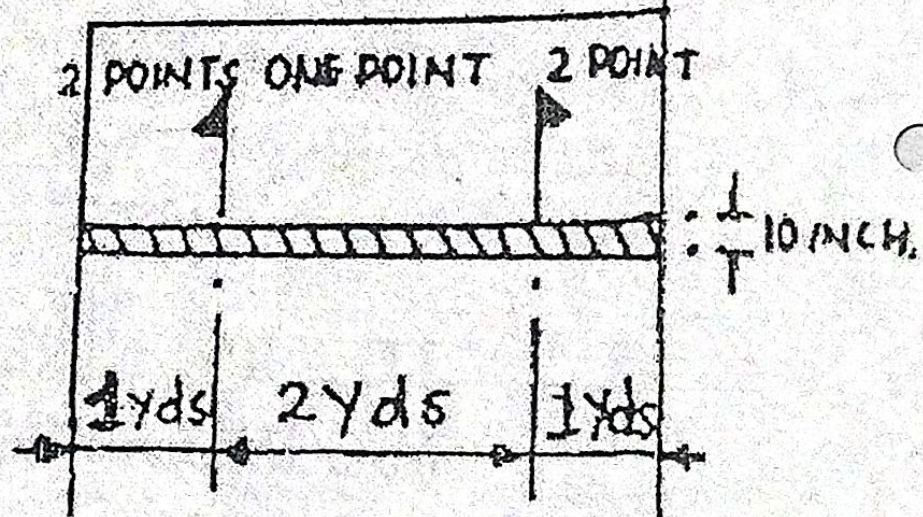

3 yds
 6.4, 2 13.5
 ○○○○○○

GOAL



SHOOTING TEST

CHIKKANNA GOVERNMENT ARTS COLLEGE, Tirupur
DEPARTMENT PHYSICAL EDUCATION

VOUCHERS FOR TA & DA

Name of the Competition : Bharathiyar University Cricket Mat
 Date of the Competition : 20, 23 & 25 September 2019.
 Venue of the Competition : Sri Rama Krishna Arts College, Periyano
 Kampala

S.No	Name of the Students	Class	TA (3days)	DA (3days)	Total	Signature
1.	P. MUTHU RAJ	I M.COM	420	375	795	P. Muthu Raj
2.	S. SARAVANA PANDI	II B.COM	420	375	795	S. Saravana Pandi
3.	V. Sureshkumar	I BA-Eng	420	375	795	V. Sureshkumar
4.	P. ARUN PANDIAN	I B.COM	420	375	795	P. Arun Pandian
5.	S. VIKRAM	I B.COM	420	375	795	S. Vikram
6.	S. PANDIYAN	II B.Sc. 200	420	375	795	S. Pandian
7.	S. Manoj	II BBA	420	375	795	S. Manoj
8.	S. Thirupandian	II B.Sc(CS)	420	375	795	S. Thirupandian
9.	D. Kastrik	II B.Sc(200)	420	375	795	D. Kastrik
10.	B. praveendraj	I BA ENG	420	375	795	B. praveendraj
11.	M. PRAVEEN KUMAR	II B.CA	420	375	795	M. Praveen Kumar
12.	P. Arunkumar	II B.Sc(200)	420	375	795	P. Arunkumar
13.	D. Arunkumar	I BA(Eng)	420	375	795	D. Arunkumar
14.	A. Muthuvel	II BA Eng	420	375	795	A. Muthuvel
15.	S. Samynathan	II B.Sc(Math)	420	375	795	S. Samynathan
16.	A. Shanmugam	III B.COM	420	375	795	A. Shanmugam
		Total			12720	
(Twelve thousand Seven hundred and Twenty Only)						

[Signature]
18/10/19

PRINCIPAL

[Signature]
18/10/19
PHYSICAL DIRECTOR

PUSHING TEST

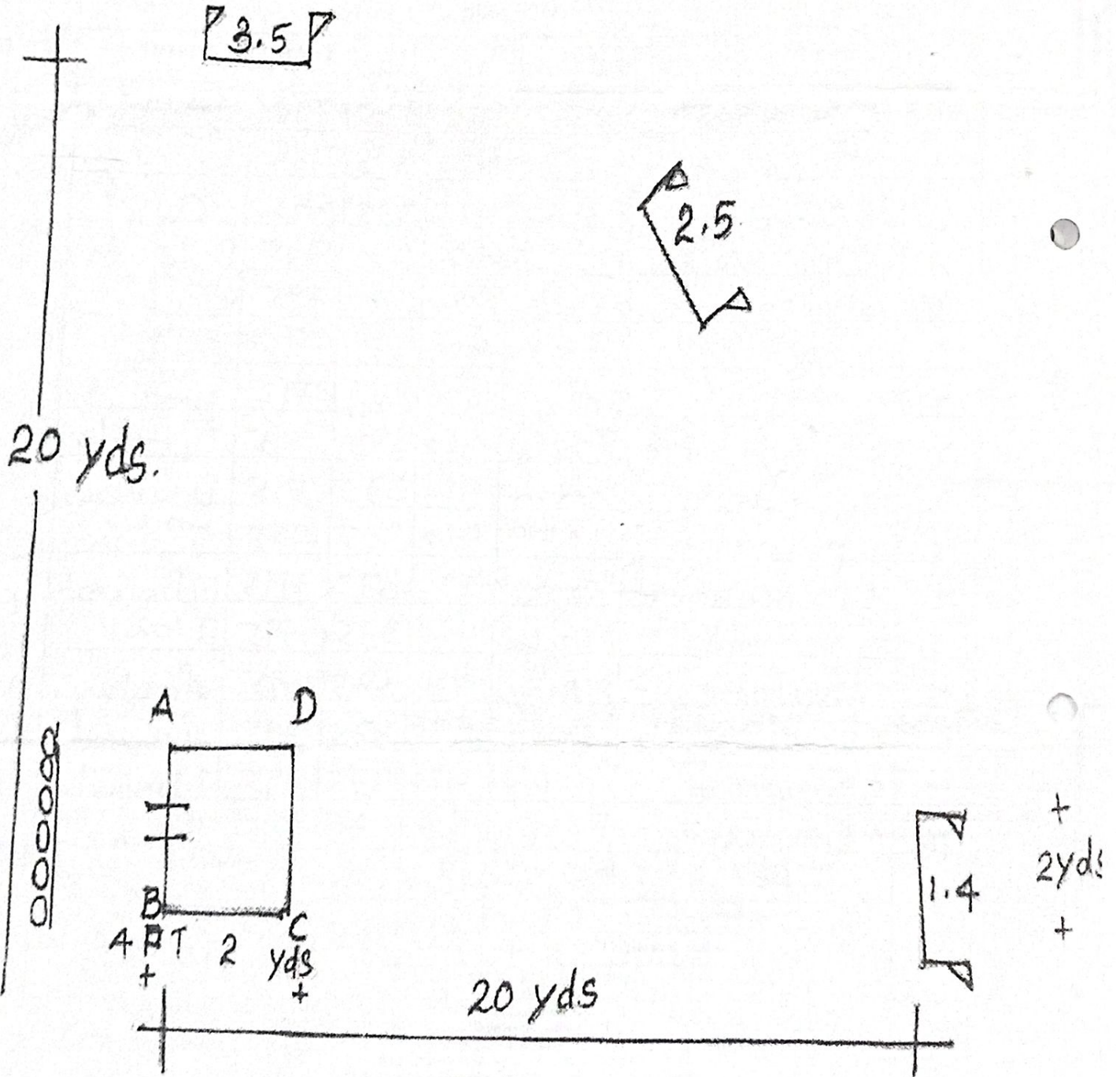



ESTIMATE

PH: 81220 31995
79049 00753

NO : _____

DATE: 27/09/19

QUANTITY	RATE	PARTICLARS	TOTAL
12	350	Top and shorts KABADDI Ghanta	12 x 350
			4,200/-



ESTIMATE

PH: 81220 319
79049 007

NO : _____

DATE : 27/09/19

QUANTITY	RATE	PARTICLARS	TOT
12	350	Top and Shovles KABADDI Ginsat	12 x
			4,20

BHARATHIAR UNIVERSITY, COIMBATORE

Inter - Collegiate Hockey Tournament for Men 2019 - 2020

Venue	Kumaraguru Liberal Arts and Science College, Cbe	
Date	03.09.2019 to 05.09.2019	
Convener	Mr. D. Balamurugan	Mobile No: 90477 43835

Fixtures

1	PSG CAS			
2	SMS College of Arts & Science		03.09.19 7.00am	
3	CMS			04.09.19 A 7.00am
4	RVS Arts		03.09.19 8.00am	
5	Kongu Arts			
6	Kongunadu CAS		03.09.19 9.00am	
7	Govt. Ooty			04.09.19 B 8.00am
8	Vidyasagar Arts		03.09.19 10.00am	
9	Nandha Arts			
10	Chikkanna Art Tiru		03.09.19 2.00pm	
11	Sri Krishna Arts			04.09.19 C 9.00am
12	KG College		03.09.19 3.00pm	
13	Govt. Udumelpet			
14	BU Dept		03.09.19 4.00pm	
15	Dr. NGP Arts			04.09.19 D 10.00am

(Signature)

Director of Physical Education i/c
Bharathiar University,
Coimbatore - 641 046.

BHARATHIAR UNIVERSITY, COIMBATORE - 641 046

Inter - Collegiate Football B - Zone Tournament for Men 2019 - 2020

Venue	PSG Arts and Science College, Cbe	
Date	12.09.2019 to 14.09.2019	
Convener	Dr. B. Navaneethan	Mobile No:9894188251

Fixtures

1 . RVS College of Arts & Science					
2 Bishop Appasamy CAS		12.09.19			
3 ChikkannaGovt Arts College, Tirupur		9.00am			
4 Kathir College of Arts & Science				13.09.19	
5 Sri JayendraSaraswathy CAS				9.00am	
6 Sri RamalingaSowdambigai College		12.09.19			
7 TIPS College of Arts & Science		10.00am			
8 NIFT TEA College					14.09.19
9 Govt Arts College, Coimbatore					7.00am
10 Hindusthan College of Arts & Science					
11 Terfs Academy College of Arts & Science					
12 Sasurie College of Arts & Science		12.09.19			
13 BU CAS, Thondamuthur		7.00am			
14 Kamban College of Arts & Science				13.09.19	
15 Kovai Kalaimagal CAS				4.00pm	
16 KSG College of Arts & Science		12.09.19			
17 SMS College of Arts & Science		11.00am			
18 PSG College of Arts & Science					14.09.19

• Third & Fourth Match will be conducted on 14.09.19 at 2.00pm

 Director of Physical Education i/c
 Bharathiar University,
 Coimbatore - 641 046.

BHARATHIAR UNIVERSITY, COIMBATORE - 641 046

Inter - Collegiate Cricket B Zone Tournament for Men 2019 - 2020

Venue	Ramaleshna Mission Vidyalyaya CAS, Periyannaalamper
Date	
Convener	R. Ambrose MSc

Fixtures

1	Park College				
2	Sasurie CAS			18.09.19	
3	Bishop Appasamy CAS			12.00am	
4	Sri Jayendra Saraswathy CAS				22.09.19
5	SMS College of Arts & Science				12.00pm
6	TIPS College of Arts & Science		16.09.19		
7	KSG College of Arts & Science		8.00am		
8	Sri Ramalinga Sowdambigai CAS			19.09.19	
9	KovaiKalaimagal CAS			8.00am	
10	Chikkanna Govt CAS, Tirupur		16.09.19		
11	Govt Arts College, Coimbatore		12.00pm		
12	Bishop Ambrose College				
13	Kamban College of Arts & Science			19.09.19	
14	RVS College of Arts & Science			12.00am	
15	NIFT TEA College				23.09.19
16	BU CAS, Thondamuthur		17.09.19		
17	Hindusthan CAS		12.00am		
18	Kathir College of Arts & Science			21.09.19	
19	Terfs Academy CAS			8.00am	
20	AG College				24.09.19
21	PSG College of Arts & Science				8.00am
				20.09.19	
				8.00am	
				20.09.19	
				12.00pm	
					23.09.19
					12.00pm
				17.09.19	
				12.00am	
				21.09.19	
				8.00am	
				18.09.19	
				8.00am	
				21.09.19	
				12.00pm	
					24.09.19
					8.00am
				22.09.19	
				8.00am	

• Third & Fourth Match will be conducted on 26.09.19 at 8.00am

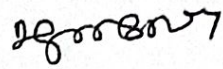
 Director of Physical Education i/c
 Bharathiar University,
 Coimbatore - 641 046.

BHARATHIAR UNIVERSITY, COIMBATORE – 641 046

Inter - Collegiate Kabaddi B - Zone Tournament for Men 2019 - 2020

Venue	Sri Ramalinga Sowdambigai College, Coimbatore – 641 109.
Date	30.09.2019 to 01.10.2019
Convener	Mr. R. Jeyith Mobile NO: 8608605745

	Fixtures		
1 Hindusthan College of Arts & Science			
2 Sasurie College of Arts & Science		30.09.19 10.00am	
3 TPS College of Arts & Science			
4 BU CAS, Thondamuthur	30.09.19 7.00am		30.09.19 3.00pm
5 Kathir College of Arts & Science		30.09.19 12.00pm	
6 Terfs Academy CAS	30.09.19 7.00am		01.10.19 8.00am
7 SMS College of Arts & Science			
8 AG CAS	30.09.19 8.00am		
9 KovaiKalaimagal CAS		30.09.19 3.00pm	
10 Park CAS			30.09.19 3.00pm
11 RVS CAS		30.09.19 10.00am	
12 Sri RamalingaSowdambigai CAS			01.10.19 4.00pm
13 PSG College of Arts & Science		30.09.19 11.00am	
14 ChikkannaGovt Arts College, Tirupur	30.09.19 8.00am		30.09.19 4.00pm
15 Bishop Appasamy CAS		30.09.19 2.00pm	
16 Bishop Ambrose College	30.09.19 9.00am		
17 KSG College of Arts & Science			01.10.19 9.00am
18 Kamban College of Arts & Science	30.09.19 9.00am		
19 Govt Arts College, Avinashi		30.09.19 2.00pm	
20 Sri JayendraSaraswathy CAS			30.09.19 4.00pm
21 NIFT TEA College		30.09.19 11.00pm	
22 Govt Arts College, Coimbatore			

• Third & Fourth Match will be conducted on 01.10.2019 at 2.00pm

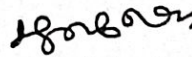
 Director of Physical Education i/c
 Bharathiar University,
 Coimbatore - 641 046.

BHARATHIAR UNIVERSITY, COIMBATORE

Volleyball B- Zone

Inter - Collegiate 23.09.19 B - Zone Tournament for Men 2019 - 2020

Venue	KPR College of Arts & Science , Arasur , Coimbatore	
Date	23.09.2019 to 24.09.2019	
Convener	Mr.V.Thambidurai	
		Mobile No: 9965631792

Fixtures

1	RVS						
2	Terf Academy		23.09.2019				
3	Sri Jayandra CAS		10.00am				
4	AG College CAS	23.09.19		23.09.2019		3.00pm	
5	SMS CAS	7.00am		12.00pm			
6	HI CAS	23.09.19		8.00am			
7	Park College					24.09.19	
8	Sasurie CAS	23.09.2019		9.00am		7.00am	
9	Nift Tea CAS		23.09.2019	2.00pm			
10	Kamban CAS				23.09.2019	3.00pm	
11	Govt. Arts Cbe		23.09.2019	11.00am			
12	Chickna Tirupur						
13	Kovai Kalai CAS		23.09.2019	10.00am		4.00pm	
14	Kathir CAS				23.09.2019		
15	KPR CAS	23.09.2019		7.00am		4.00pm	
16	Bishop Ambrose CAS		23.09.19	12.00pm			
17	Ramalinga Sowdambigai	23.09.19		8.00am			
18	BU CAS Thondamuthur					24.09.19	
19	TIPS	23.09.2019		9.00am		8.00am	
20	Bishop Appasamy		23.09.19	2.00pm			
21	KSG CAS				23.09.2019		
22	PSG CAS		23.09.19	11.00am		4.00pm	

• Third & Fourth Match will be conducted on 24.09.2019 at 2.00pm

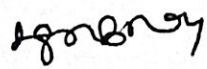
 Director of Physical Education i/c
 Bharathiar University,
 Coimbatore - 641 046.

Chikkanna Government Arts College, Tiruppur - 641 602				
5.3.2 Average number of sports and cultural programs in which students of the Institution participated during last five years (organised by the institution/other institutions)				
YEAR -I (2022-23)				
S. No.	Date of event/activity (DD-MM-YYYY)	Name of the event/activity	Name of the organising institution	Name of the student participated
1	24-02-2023 & 25-02-2023	Shrista'23- Cricket	Sasurie Institutions	K. RAGURAM
2				N. S. KARTHIKEYAN
3	08-02-2023	CM Trophy Cricket	Youth Welfare and Sports Development Department	K. RAGURAM
4				N. S. KARTHIKEYAN
5	21-02-2023	Essay Writing-75th Independence day Amudha Peru Vizha	Fine Arts Club- CGAC	V. SAIKIRUBA
6	24-09-2022	NSS Day- Relay	NSS Unit- CGAC	M. HARIPRASATH
7	24-09-2022	NSS Day- Carrom	NSS Unit- CGAC	M. HARIPRASATH
8	24-09-2022	NSS Day- Shuttle Badminton	NSS Unit- CGAC	M. HARIPRASATH
9	22-03-2023	State level Chess	Chanakya Chess Academy	M. HARIPRASATH
10	20-11-2022	2nd Azure Coimbatore District level Chess	Azure Chess Institute	M. HARIPRASATH
11	24-09-2022	NSS Day- Chess	NSS Unit- CGAC	M. HARIPRASATH
12	30-08-2022	District level Elocution	Sri Ramakrishna Mission Vidyalaya College of Arts and Science	S. SANTHOSH
13	30-08-2022	District level Elocution	Sri Ramakrishna Mission Vidyalaya College of Arts and Science	S. SASI VIKRAM
14	30-08-2022	District level Elocution	Sri Ramakrishna Mission Vidyalaya College of Arts and Science	S. BRINDHA
15	12-12-2022	Elocution- Tamil	Bharathiar University	S. BRINDHA
16	21-02-2023	Speech -75th Independence day Amudha Peru Vizha	Fine Arts Club- CGAC	S. BRINDHA
17	19-02-2023	Speech - Vallalar Mupperum Vizha	Hindu Religious & Charitable Endowments	S. BRINDHA
18	27-01-2023	20th Intercollegiate Speech	PSG College of Technology	S. BRINDHA
19	15-03-2023	Tamil Aatchi Mozhi Satta Varam- Debate	Tamil Development Department	S. BRINDHA
20	27-11-2022	Ideological Tamil Speech Competition	Coimbatore Govt. Arts College	S. BRINDHA
21	03-06-2023	Elocution- Tamil	Tamil Development Department	S. BRINDHA
22	19-02-2023	Essay Writing - Vallalar Mupperum Vizha	Hindu Religious & Charitable Endowments	L. AISHWARYA
23	12-11-2022	District level Elocution	Tamil Development Department	S. BRINDHA
24	29-01-2023	State level Open Kata Championship- 2023	Power Shotokan Karate do Association	V. NIRAIMATHI
25	07-10-2023	Arignar Anna Marathon Run-2023	Sports Development Authority of TamilNadu	P. AGALYA
26	20-01-2023	7th Tiruppur District Taekwondo Championship 2023-24	Tiruppur District Taekwondo Association	P. AGALYA
27	19-01-2023	Colour Belt Certificate	Tamilnadu Taekwondo Association	P. AGALYA
28	09-02-2023	CM Trophy Hockey	Youth Welfare and Sports Development Department	V. SELVAKUMAR
29	18-10-2022	Hockey Intercollegiate Tournament	Bharathiar University	V. SELVAKUMAR
30	14-11-2022	Tiruppur District College Speech Competition	Tamil Development Department	S. NAGARAJ
31	12-11-2022	Ilambharathi Virudhu 2022- Essay Writing	Bharathiar University	K. SHAMIYA
32	12-11-2022	Ilambharathi Virudhu 2022- Poetry	Bharathiar University	K. YUVASHREE
33	24-01-2023	Swami Vivekananda Thought Festival- Painting Competition	Bharathiar University	A. SUBHASH

34	24-01-2023	Swami Vivekananda Thought Festival- Painting Competition	Bharathiar University	M. SANMUGAVALLI
35	24-01-2023	Swami Vivekananda Thought Festival- Painting Competition	Bharathiar University	R. SANDHYA
36	24-01-2023	Swami Vivekananda Thought Festival- Painting Competition	Bharathiar University	T. MANOJKUMAR
37	27-01-2023	20th Intercollegiate Speech	PSG College of Technology	R. SANDHYA
38	27-01-2023	20th Intercollegiate Speech	PSG College of Technology	S. NAGARAJ
39	03-03-2023	State level Speech Competition	Central Law College Salem	S. NAGARAJ
40	15-03-2023 to 21-03-2023	Ilanthamizh Ilakkiya Payirchi Pattarai	Tamil Development Department	S. NAGARAJ
41	15-03-2023	Essay competition	Tirupur Department of Placement and Training	C. SANGEETHA
42	15-03-2023	Essay competition	Tirupur Department of Placement and Training	E. ELANGAVIYA
43	16-03-2023	Essay competition	Tirupur Department of Placement and Training	A. SANDHYA
44	21-03-2023	75th Independence Festival- Quiz	Ministry of Information and Broadcasting	S. KANNAN
45	21-03-2023	75th Independence Festival- Quiz	Ministry of Information and Broadcasting	K. MUGHILAN
46	27-03-2023	Speech Competition	Tamil Development Department	S. BRINDHA
47	27-03-2023	Poetry Competition	Tamil Development Department	C. SANGEETHA
48	27-03-2023	Poetry Competition	Tamil Development Department	P. VIJAYARAJ
49	09-02-2023	CM Trophy Hockey	Youth Welfare and Sports Development Department	R. ANITHA
50				G. ESHWARIPRIYA
51				V. RENUGA
52				S. SHALINI
53				T. TRISHA
54				S. NISHANA
55				P. AGALYA
56	15-02-2023	CM Trophy Football	Youth Welfare and Sports Development Department	R. ANITHA
57				V. RENUGA
58				S. SHALINI
59				T. TRISHA
60				S. NISHANA
61				P. AGALYA
62	09-11-2022	Inter Collegiate Hockey Tournament	Bharathiar University	S. AGATHIYAN
63				S. JEEVA
64				S. DHANUSH
65				S. SURENDRAN
66				S. MALARAVAN
67				G. SHANMUGANATHAN
68				S. SURIYAPRAKASH
69				A. AKASH
70				G. MANIKANDAN
71				S. PRABHAKARAN

72				T. SINGAPRAKASH
73				M. SURYA
74				M. KARTHEESHWARAN
75				S. SATHEESHWARAN
76				R. HARIHARAN
77				V. SELVAKUMAR
78	11-12-2022 to 16-12-2022	Inter-University Tournament- Hockey	Bangalore City University	V. SELVAKUMAR
79				R. ASHWINKUMAR
80				A. AKASH
81				S. SURIYAPRAKASH
82	18-08-2022	Body Building Championship-2022	Tiruppur District Amateure Body Building Association	S. DINESHKUMAR
83	02-07-2023	34th Tamilnadu State Taekwondo Championship	Sports Taekwondo Association Thiruvaur District	P. AGALYA
84	17-09-2023	Colour Belt Certificate	Tamilnadu Taekwondo Association	P. AGALYA
85	13-08-2023	5th Tiruppur District Atheletic Championship- Long jump	Tiruppur Atheletic Association	P. AGALYA
86	25-06-2023	8th Tiruppur District Taekwondo Championship 2023-24	Tiruppur District Taekwondo Association	P. AGALYA
YEAR - II (2021-22)				
S. No.	Date of event/activity (DD-MM-YYYY)	Name of the event/activity	Name of the organising institution	Name of the student participated
1	17-09-2021 to 19-09-2021	Boxing- National all games Championship	Students Sports Development Association of India	K. NARENDRAN
2	15-08-2021	6th Mr. Muscle Mania	Indian Fitness Federation	S. DINESH
3	07-12-2021	75th Independence Day Elocution - Tamil	CGAC	S. BRINDHA
4	07-01-2022 & 08-01-2022	Ooty National Taekwondo Championship	SG Master Taekwondo Centre	P. AGALYA
5	26-11-2021 to 28-11-2021	National Championship- Chess	School Games and Activity Development Foundation	T. VASUKI DEVI
6				A. MOHAMMAD IBRAHIM
7	09-12-2021	Drawing Copmpetition	Income Tax Department	D. S. SOUMIYA
8	09-12-2021	Drawing Copmpetition	Income Tax Department	S. VANISRI
9	26-11-2021 to 27-11-2021	National Championship- Volleyball	School Games and Activity Development Foundation	M. MANIKANDAN
10	26-11-2021 to 28-11-2021	National Championship- Kabbadi	School Games and Activity Development Foundation	M. SASIKUMAR
11				T. SEENU
12				S. SURENDHAREN
13				A. ISSA AIARIAH
14				S. THANGAPANDI
15				M. RAJKUMAR
16				R. SURYA
17				J. RAJADURAI
18				R. SURYA
19				P. VIGNESHWARAN
20				T. ALEX
21	A. NAGARJUN			

22	09-12-2021	Essay Writing	Income Tax Department	A. ELAVARASI
23	09-12-2021	Essay Writing	Income Tax Department	T. DHANUSHKUMAR
24	04-04-2022	Intercollegiate Speech	State Minorities Commission	S. S. DHANUSRI
25	25-03-2022	Intercollegiate Drawing	Tiruppur District InterCollegiate level Competition conducted by CGAC	M. KAVINKUMAR
26	25-03-2022	Intercollegiate Essay Writing	Tiruppur District InterCollegiate level Competition conducted by CGAC	R. BHARATHKUMAR
27	02-03-2022	Elocution- Tamil	Department of Civil Supplies and Consumer Protection	S. BRINDHA
28	02-03-2022	Poetry Competition	Department of Civil Supplies and Consumer Protection	P. VIJAYARAJ
29	02-03-2022	Drawing Competition	Department of Civil Supplies and Consumer Protection	M. KAVINKUMAR
30	22-03-2022	Drawing Competition	Trichy Thuya Valanaar College	M. KAVINKUMAR
31	29-10-2021	Intercollegiate Poetry Competition	Kongunadu Arts And Science College	P. VIJAYARAJ
32	26-12-2021 TO 01-01-2022	All India inter University Boxing tournament	Lovely Professional College, Jalandhar	N. JAGATHRATCHAGAN
33	27-12-2021 TO 31-12-2021	South Zone inter university hockey tournament	Bangalore Central University	S.AGATHIYAN
34	27-12-2021 TO 31-12-2021	South Zone inter university hockey tournament	Bangalore Central University	S. MALARAVAN
35	18-09-2021	Bharathiar University Inter Collegiate Boxing tournament	Bharathiar University	N. JAGATHRATCHAGAN
36				A. SELVAKUMAR
37				R. ELANKUMARAN
38	05-02-2022	Inter Collegiate Best Physique competition	Bharathiar University	S. DINESHKUMAR
39	07-12-2021	Bharathiar University Inter Collegiate Boxing tournament	Bharathiar University	S. T. KALAIVANI
40	18-12-2021	Inter Collegiate Hockey Tournament	Bharathiar University	S.AGATHIYAN
41				S.DHANUSH
42				SJEEVA
43				V.SELVAKUMAR
44	08-12-2021	Inter Collegiate Boxing Tournament	Bharathiar University	N. JAGATHRATCHAGAN
45	02-12-2021	Inter Collegiate Volleyball Tournament	Bharathiar University	College Volleyball Team
YEAR - III (2020-21)				
S. No.	Date of event/activity (DD-MM-YYYY)	Name of the event/activity	Name of the organising institution	Name of the student participated
1	21-09-2020	General Awareness Quiz	Department of RISE, Chandigarh Group of Colleges	L. JOHNPAUL
2	23-01-2021 & 24-01-2021	DISTRICT LEVEL SILAMBAM TOURNAMENT	TIRUPUR DISTRICT SILAMBAM ASSOCIATION	G.MONISHA
3	06-06-2020	Literary Quiz	Dept. of English CGAC	S. DHARANI
4	20-05-2020	E- Quiz on English Grammar	Arignar Anna Govt. Arts and Science College	S. RAGUL
5	16-04-2020	Quiz on Basics of Computer	Govt. Arts and Science College Karimangalam	S. RAGUL
6	14-03-2021	Mr. Anytime Classic Body Building Championship-2021	Tiruppur District Amateurs Body Building Association	E. SANJEEV
7	06-03-2021	Mr. Tiruppur Body Building Championship-2021	Tiruppur District Amateurs Body Building Association	E. SANJEEV
8	28-03-2021	Spiritual World Record 2021	The World Community Service Centre	M. SURESHKUMAR
9	28-03-2021	Spiritual World Record 2021	The World Community Service Centre	ARULKUMAR
10	28-03-2021	Spiritual World Record 2021	The World Community Service Centre	R. AKILPRASATH
11	22-03-2021 to 28-03-2021	National Integration Camp for Women	NSS-Karnataka State Akkamahadevi Women's University	M. KEERTHANA
YEAR - IV (2019-20)				

S. No.	Date of event/activity (DD-MM-YYYY)	Name of the event/activity	Name of the organising institution	Name of the student participated
1	27-04-2019 & 28-04-2019	NATIONAL PRO ARM CHAMPION	INDIAN FITNESS FEDERATION	S.DHANUSHKUMAR
2	23-06-2019	OPEN STATE LEVEL BODY BUILDING AND FITNESS CHAMPION	INDIAN FITNESS FEDERATION	S.DHANUSHKUMAR
3	01-10-2019	BHARATHIAR UNIVERSITY INTER COLLEGIATE BEST PHYSIQUE	KONGU ARTS COLLEG	S.DHANUSHKUMAR
4	08-01-2020	BHARATHIAR UNIVERSITY INTER COLLEGIATE TAEKWONDO	NIRMALA ARTS COLLEGE	N.JANSHIRANI
5	12-01-2020	DISTRICT LEVEL CHESS TOURNAMENT	KAMATCHI AMMAN KALYANAMADAPAM	A.MOHMAD IBRAHIM
6	31-01-2020 to 02-02-2020	INDIAN RINK FOOTBALL LEAGUE -2	INDIAN RINK FOOTBALL FEDERATION	MOUNISH BABU
7	16-12-2019 TO 20-12-2019	NATIONAL LEVEL BOXING TOURNAMENT	SONIPAT, HARYANA	K.NARENDRAN
8	14-10-2019	NATIONAL LEVEL BOXING TOURNAMENT	UNIVERSITY OF RAJSSTAN, JAIPUR	K.NARENDRAN
9	15-06-2019 16-06-2019	DISTRICT LEVEL WRESTLING TOURNAMENT	SALEM DISTRICT WRESTLING ASSOCIATION	P.RAMESH
10	03-05-2019 TO 05-05-2019	STATE LEVEL WRESTLING TOURNAMENT	TAMILNADU WRESTLING ASSOCIATION	P.RAMESH
11	12-01-2020	DISTRICT LEVEL CHESS TOURNAMENT	KAMATCHI AMMAN KALYANAMADAPAM	T.VASUKIDEVI
YEAR - V (2018-19)				
S. No.	Date of event/activity (DD-MM-YYYY)	Name of the event/activity	Name of the organising institution	Name of the student participated
1	24-12-2018 TO 03-01-2019	HOCKEY	NAGARCHUNA UNIVERSITY, (AP)	S.KAVIYARASU
2	24-12-2018 TO 03-01-2019	HOCKEY	NAGARCHUNA UNIVERSITY, (AP)	N.KULANDAIVEL
3	22-02-2019 TO 28-02-2019	BOXING	VIDHYABEETH UNIVERSITY	ELANKUMARAN
4	07-11-2019	TAEKWONDO	NEHRU ARTS COLLEGE, COIMBATORE	S.DHANUSHKUMAR
5	10-10-2018	BEST PHYSIQUE	KONGU ARTS COLLEGE, ERODE	S.DHANUSHKUMAR



PRINCIPAL
 Chikkanna Govt. Arts College
 Tirupur

5.3.2 Average number of sports and cultural programs in which students of the Institution participated during last five years (organised by the institution/other institutions)- Supporting documents

2022-23





இளைஞர் நலன் மற்றும் விளையாட்டு மேம்பாட்டுத்துறை
தமிழ்நாடு விளையாட்டு மேம்பாட்டு ஆணையம்
முதலமைச்சர் கோப்பை

மாஸ்ட். அளவிலான விளையாட்டுப் போட்டிகள் 2022 - 2023

பாராட்டுச் சான்றிதழ்

திருமிது ரதாம் K அவர்கள் 08.02.2023 அன்று நடைபெற்ற
யு.சுடப்பந்து போட்டியில் கல்லூரிப் பிரிவில் பங்கேற்று கங்கப் பதக்கம்
வென்றதைப் பாராட்டி இச்சான்றிதழ் வழங்கப்படுகிறது.

மாஸ்ட். விளையாட்டு அலுவலர்
கிரீப்புர் மாஸ்ட்ம்

மாஸ்ட். ஆபிசுத்தலைவர்
கிரீப்புர் மாஸ்ட்ம்



இளைஞர் நலன் மற்றும் விளையாட்டு மேம்பாட்டுத்துறை
தமிழ்நாடு விளையாட்டு மேம்பாட்டு ஆணையம்
முதலமைச்சர் கோப்பை

மாஸ்ட். அளவிலான விளையாட்டுப் போட்டிகள் 2022 - 2023

பாராட்டுச் சான்றிதழ்

திருமிது கந்தகேயல் NS அவர்கள் 08.02.2023 அன்று நடைபெற்ற
யு.சுடப்பந்து போட்டியில் கல்லூரிப் பிரிவில் பங்கேற்று கங்கப் பதக்கம்
வென்றதைப் பாராட்டி இச்சான்றிதழ் வழங்கப்படுகிறது.

மாஸ்ட். விளையாட்டு அலுவலர்
கிரீப்புர் மாஸ்ட்ம்

மாஸ்ட். ஆபிசுத்தலைவர்
கிரீப்புர் மாஸ்ட்ம்





சிக்கண்டா அரசு கலைக் கல்லூரி, திருப்பூர்
 CHIKKANNA GOVERNMENT ARTS COLLEGE: TIRUPPUR



Fine Arts Club துணைக் கல்வி அமைச்சு

CERTIFICATE

OF APPRECIATION மனதாரக் கவனிப்பு

This is to certify that Mr / Ms SAI KIRUBA . V Reg.No. 2131E0003

Studying B.A in ENGLISH LITERATURE during the Academic year 2021 - 2023

has participated in ESSAY WRITING and Secured the FIRST prize in event

75th INDEPENDENCE DAY AMUDHA PERU VIZHA conducted in the college premises

21-02-2023

DATE



[Handwritten Signature]

SIGNATURE





National Service Scheme NSS Unit - II
CHIKKANNA GOVT ARTS COLLEGE
(Affiliated to Bharathiar University)
Tiruppur 641 602, Tamilnadu
NSS DAY - 24.09.2022

CERTIFICATE

This is to certify that M. HARI PRASATH, NSS - 2, of
II, BBA, has secured FIRST PLACE in the
event CARROM conducted for NSS Day 2022.
I wish him/her all success.

Dr. A. Mohan Kumar
Dr. A. MOHAN KUMAR
NSS - 2 Programme Officer

Dr. V. Krishnan
DR. V. KRISHNAN
PRINCIPAL

Kranthi Kumar Pati
KRANTHI KUMAR PATI, I.A.S.
Tiruppur Corporation Commissioner



National Service Scheme NSS Unit - II
CHIKKANNA GOVT ARTS COLLEGE
(Affiliated to Bharathiar University)
Tiruppur 641 602, Tamilnadu
NSS DAY - 24.09.2022

CERTIFICATE

This is to certify that M. HARI PRASATH, NSS - 2, of
II, BBA, has secured FIRST PLACE in the
event SHUTTLE RACKET conducted for NSS Day 2022.
I wish him/her all success.

Dr. A. Mohan Kumar
Dr. A. MOHAN KUMAR
NSS - 2 Programme Officer

Dr. V. Krishnan
DR. V. KRISHNAN
PRINCIPAL

Kranthi Kumar Pati
KRANTHI KUMAR PATI, I.A.S.
Tiruppur Corporation Commissioner



National Service Scheme NSS Unit - II
CHIKKANNA GOVT ARTS COLLEGE
(Affiliated to Bharathiar University)

Tiruppur 641 602, Tamilnadu

NSS DAY - 24.09.2022

CERTIFICATE

This is to certify that ...M...HARIBASATH...NSS-2..... of
.....III...B.A...... has secured FIRST PLACE..... in the
eventCHESS..... conducted for NSS Day 2022.

I wish him/her all success.

Dr. A. MOHANKUMAR
NSS-2 Programme Officer

DR. V. KRISHNAN
PRINCIPAL

KRANTHI KUMAR PALI, I.A.S.
Tiruppur Corporation Commissioner



Arise! Awake!
Sleep not till the
goal is reached.

Sri Ramakrishna Mission Vidyalaya College of Arts and Science

Chikkana - 541 020



125th Anniversary of Ramakrishna Mission
&
75th Anniversary of Indian Independence



Literary Competitions

Certificate

This is to certify that Selvan / Selvi SANTHOSH . S
studying in Chikkanna Government
Arts College has
been awarded Fourth place in the State / District Level Education /
Poetry Writing Competition in Tamil / English conducted on account of 125th Anniversary of
Ramakrishna Mission & 75th Anniversary of Indian Independence Day Celebrations,
held on 30-08-2022.

K. Anand
Coordinator
Sri Ramakrishna Mission Vidyalaya College of Arts and Science

Dr. R. Mangavel
Dr. R. Mangavel
Sri Ramakrishna Mission Vidyalaya College of Arts and Science

Swami Garishthananda
Swami Garishthananda
Secretary
Ramakrishna Mission Vidyalaya Institutions



Sri Ramakrishna Mission Vidyalaya College of Arts and Science

Chikkana - 541 020



125th Anniversary of Ramakrishna Mission
&
75th Anniversary of Indian Independence



Literary Competitions

Participation Certificate

This is to certify that Selvan / Selvi S. SASI VEEAM
studying in BCA of CHIKKANNA GOVERNMENT
ARTS COLLEGE TIKUPPUR has
participated in State / District Level Education / Poetry Writing Competition in Tamil / English
conducted on account of 125th Anniversary of Ramakrishna Mission & 75th Anniversary of Indian
Independence Day Celebrations, held on 30-08-2022.

K. Anand
Coordinator
Sri Ramakrishna Mission Vidyalaya College of Arts and Science

Swami Garishthananda
Swami Garishthananda
Secretary
Ramakrishna Mission Vidyalaya Institutions







பி.எஸ்.சி தொழில்நுட்ப மற்றும் பன்தொழில்நுட்பக் கல்லூரி
 முன்னாள் மாணவர் சங்கம்
 கோயம்புத்தூர் - 641004.
 20-வது மாநில அனைவிரான கல்லூரிகளுக்கிடையேயான
 பேச்சுப்போட்டி



நற்சான்றிதழ்

பி.எஸ்.சி தொழில்நுட்ப மற்றும் பன்தொழில்நுட்பக் கல்லூரியின் முன்னாள்
 மாணவர் சங்கத்தின் சார்பில் 27.01.2023 அன்று நடைபெற்ற 20-வது
 கல்லூரிகளுக்கிடையேயான பேச்சுப்போட்டியில்**சு. பிஷா**.....
 சிறப்பான**விழை தலை உயர்ந்த**..... பங்கேற்றமைக்காக வாழ்த்துபெறும்.

பொது செயலாளர்

தலைவர்

ஸ்வர்



தமிழக அரசு
தமிழ் வளர்ச்சித் துறை
 திருச்சி மாவட்டம்



தமிழ் ஆய்வினொழிச் சட்ட வாரம்
ஸ்ரீமதி சார்மினி

தலைவரவர்களே 2014, மார்ச்சு திங்கள் 09.03.2023 முதல் 16.03.2023 வரை
 தமிழ் வளர்ச்சித் துறையான திருச்சி மாவட்டத்தில் நடைபெற்ற ஆய்வினொழிச் சட்ட வாரம் தொடர்பான
 விழாவில் 15.03.2023 ஆம் திகதி நடைபெற்ற மாநாட்டில் திரு. சிவசுந்தர சிவசுந்தர சிவசுந்தர
 கல்லூரியில் பி.எஸ்.சி தொழில்நுட்ப மற்றும் பன்தொழில்நுட்பக் கல்லூரி சார்பில்
 விழாவுக்கு கலந்து கொண்டமைக்காக மாநாட்டில் பங்கேற்றமைக்காக வாழ்த்துபெறும்.

ம. சிவசுந்தர
 தலைவரவர்கள் துறை திருச்சி மாவட்டம்
 திருச்சி மாவட்டம்.









7th TIRUPPUR DISTRICT TAEKWONDO CHAMPIONSHIP 2022-2023

Organized by :

TIRUPPUR DISTRICT TAEKWONDO ASSOCIATION

Affiliated to :

TAMILNADU TAEKWONDO ASSOCIATION

TAEKWONDO FEDERATION OF INDIA

TAMILNADU STATE OLYMPIC ASSOCIATION

Recognised by :

SPORTS DEVELOPMENT AUTHORITY OF TAMILNADU

태
권
도

태
권
도

CERTIFICATE

This is to certify that Miss/Mr. P. AGALYA
of CGAC TIRUPPUR has participated as a
Competitor / Official / Referee in the **TAEKWONDO** Championship
held on 20th January 2023 at M.N. Chikkanna Chettiar Matriculation
School, Palayakkadu, Uthukuli Road, Tiruppur and is awarded
GOLD medal in JUN.-UN.-46 Weight Category.

M. MUTHU KUMAR
President
Tiruppur District Taekwondo Association

A. J. ABRAHAM LINCOLN
Referee
General secretary, Chief Referee
Tiruppur District Taekwondo Association

P. SELVAMANI M.A.,
General secretary, Chief Technical Director
Tamil Nadu Taekwondo Association

தமிழ்நாடு தேக்வாண்டோ சங்கம் (பதிவு)
TAMIL NADU TAEKWONDO ASSOCIATION®

Contact Address : No. 646/4, Govindasamy Street, Vanniyaar Nagar, Periyapudhur, SALEM - 636 016.

Affiliated to
TAMILNADU STATE OLYMPIC ASSOCIATION

web : www.tnta.org.in

Recognised by
SPORTS DEVELOPMENT AUTHORITY OF TAMILNADU



COLOUR BELT CERTIFICATE

No. : 4573

This is to certify that

P. ABALYA

having succeeded in the requisite examination, has been granted

WHITE 1, ~~YELLOW~~ GREEN 1 BLUE

RED BELT 5th grade by the reviewing
Technical Committee of the Association,
this 19th day of Jan 2023

எ
ந
உ



A.J. ABRAHAM LINCOLN
GENERAL SECRETARY
3RD DAN BLACK BELT (WTF KUKKIWOON) NATIONAL REFEREE
TRUPPUR DISTRICT TAEKWONDO ASSOCIATION®
24, SODUKKUMBA NAGAR, METTUR, PERIYAPUDHUR, SALEM.
CELL No : 94455 44495
Association.

Grand Master P. SELVAMANI, 8th DAN
7th Dan Black Belt, (Kukkiwon, Korea)
International Referee
General Secretary & Chief Technical Director,
TAMILNADU TAEKWONDO ASSOCIATION.

Dr. ISHARI K. GANESH, M.Com., M.B.A., B.L., Ph.D.
(Founder - Chancellor, VELS University, Chennai.)
President
TAMILNADU TAEKWONDO ASSOCIATION.



இளைஞர் நலன் மற்றும் விளையாட்டு மேம்பாட்டுத்துறை
தமிழ்நாடு விளையாட்டு மேம்பாட்டு ஆணையம்
முதலமைச்சர் கோப்பை

மாநில அளவிலான விளையாட்டுப் போட்டிகள் 2022 - 2023

பாராட்டுச் சான்றிதழ்

திருமிகு செல்வகுமார் V அவர்கள் 09.02.2023 அன்று நடைபெற்ற
வால்கோல்பந்து போட்டியில் கல்யாணி பிரிவில் பங்கேற்று வெள்ளி பதக்கம்
வென்றதைப் பாராட்டி இச்சான்றிதழ் வழங்கப்படுகிறது.

செல்வகுமார் V
மாநில விளையாட்டு அலுவலர்
விருப்பம் மாநிலம்

செல்வகுமார் V
மாநில ஆட்சித்தலைவர்
விருப்பம் மாநிலம்



BHARATHIAR UNIVERSITY

COIMBATORE - 641 046.

C.No. 1358

INTER-COLLEGIATE TOURNAMENTS

2022 - 2023

CERTIFICATE OF MERIT

Name : V. SELVA KUMAR
Institution : CHIKKANNA Sport Arts COLLEGE
Degree : M.Sc (PHYSICS) Year - II Date of Birth 20.09.2002
Event : HOCKEY
Place : RUNNER - UP
Performance : _____ Date: 18.10.2022

செல்வகுமார் V
Director of Physical Education i/c.

N. Sankaranarayanan
Vice - Chancellor Committee



பாரதியார் பல்கலைக்கழகம்

அரசுப் பல்கலைக்கழகம்
கோயம்புத்தூர் - 641 046.

(நெசியத்தா மதிப்பீடுக் குழுவின் 'டி' சான்றிதழ் பெற்றது)



மகாகவி பாரதியார் பிறந்த நாள் விழா

இளம் பாரதி விருது - 2022

நாள் - 12.12.2022

சான்றிதழ்

திரும்பித் தி. அழகியா, திராங்கணத்தி, தி. விஜி, இராஜிபாபாசாமி, சி. சீ. சண்முகம்...
அரசுத் தனாதி. உல்லாசர், தி. வி. பூர்..... அவர்கள் 11.12.2022 அன்று பாரதியார் பிறந்த
நாள் விழாவை முன்னிட்டு நடைபெற்ற கவிதை / கட்டுரை / பேச்சுப் போட்டியில் பங்கேற்றார் என்று
சான்றளிக்கப்பெறுகின்றது.

பெரா. முனைவர் சி. சித்ரா
ஒதுக்கீட்டாளர்
தமிழ்த்தொழில் துறை



பெரா. முனைவர் F.X. லவ்லிணா லிட்முல் டப்ளவர்
தூணியத்திப் பேரமுத்திரை உறுப்பினர்



பாரதியார் பல்கலைக்கழகம்

அரசுப் பல்கலைக்கழகம்
கோயம்புத்தூர் - 641 046.

(நெசியத்தா மதிப்பீடுக் குழுவின் 'டி' சான்றிதழ் பெற்றது)



மகாகவி பாரதியார் பிறந்த நாள் விழா

இளம் பாரதி விருது - 2022

நாள் - 12.12.2022

சான்றிதழ்

திரும்பித் தி. அழகியா, திராங்கணத்தி, தி. விஜி, இராஜிபாபாசாமி, சி. சீ. சண்முகம்...
அரசுத் தனாதி. உல்லாசர், தி. வி. பூர்..... அவர்கள் 11.12.2022 அன்று பாரதியார் பிறந்த
நாள் விழாவை முன்னிட்டு நடைபெற்ற கவிதை / கட்டுரை / பேச்சுப் போட்டியில் பங்கேற்றார் என்று
சான்றளிக்கப்பெறுகின்றது.

பெரா. முனைவர் சி. சித்ரா
ஒதுக்கீட்டாளர்
தமிழ்த்தொழில் துறை



பெரா. முனைவர் F.X. லவ்லிணா லிட்முல் டப்ளவர்
தூணியத்திப் பேரமுத்திரை உறுப்பினர்



பி.எஸ்.ஜி தொழில்நுட்ப மற்றும் பல்தொழில்நுட்பக் கல்லூரி
 முன்னாள் மாணவர் சங்கம்
 கோயம்புத்தூர், - 641004.
 20-வது மாநில அளவிலான கல்லூரிகளுக்கிடையேயான
 பேச்சுப்போட்டி



நற்சான்றிதழ்

பி.எஸ்.ஜி தொழில்நுட்ப மற்றும் பல்தொழில்நுட்பக் கல்லூரியின் முன்னாள்
 மாணவர் சங்கத்தின் சார்பில் 27.01.2023 அன்று நடைபெற்ற 20-வது
 கல்லூரிகளுக்கிடையேயான பேச்சுப்போட்டியில்
 சி. சந்திரா பங்கேற்றமைக்காக வாழ்த்துகிறோம்.





Law College, Salem

சிறப்பு விரு

TMB தமிழ்நாடு வங்கியும் பி.சி.ஐ.யும் இணைந்து

பெயர்: ச. சண்முகம் பி.என்.என். 05/09/2023

பெறு: Five thousand only ரூ. 5,000/-

அ.க. XXXXXXXXXX சி.க. XXXXXX

பெறுபெற்ற LAW COLLEGE
[Signature]
Authorized Signatory

படிப்பு & அலுவலகம்

பேரவையின் கீழ்க் கட்டப்படும் தொகை

—- உத்தரவிட்டுச் சான்றிதழ் —-

பெறுபெற்றவர் ச. சண்முகம் B.COM. Ist YEAR

05-09-2023 மதுரை கி.ஆ.செ.இ.யில் உள்ள கி.ஆ.செ.இ.யில் உள்ள கி.ஆ.செ.இ.யில் உள்ள கி.ஆ.செ.இ.யில் உள்ள

CHEKKANNA GOVERNMENT ARTS COLLEGE

மதுரை கி.ஆ.செ.இ.யில் உள்ள கி.ஆ.செ.இ.யில் உள்ள கி.ஆ.செ.இ.யில் உள்ள கி.ஆ.செ.இ.யில் உள்ள

[Signature] *[Signature]*

சுப்ப. இலா. அலுவலர் **சுப்ப. இலா. அலுவலர்**

மதுரை கி.ஆ.செ.இ.யில் உள்ள கி.ஆ.செ.இ.யில் உள்ள கி.ஆ.செ.இ.யில் உள்ள கி.ஆ.செ.இ.யில் உள்ள





On 15-03-2023 Essay Competition on "Biodiversity Conservation and Human Life" was held in our college on behalf of Tirupur, conducted by Department Placement and Training Department. 55 students participated in this event and S. Sangeetha Second year B.sc. Physics received First Prize and A. Sandhiya M.Sc.Physics First Year received third Prize at the day of 16-03-2023.



Government of India
MINISTRY OF INFORMATION AND BROADCASTING
CENTRAL BUREAU OF COMMUNICATION
Regional Office : Chennai.



Certificate of Merit

This is to certify that Selvi / Selvan S. Kannan
of Chikkanna Govt Arts College - Tiruppur
has participated in the Inter College Quiz competition conducted as a part of Exhibition on
UNsung FREEDOM FIGHTERS and CENTRAL GOVERNMENT WELFARE SCHEMES held at Coimbatore
on 21.03.2023



Government of India
MINISTRY OF INFORMATION AND BROADCASTING
CENTRAL BUREAU OF COMMUNICATION
Regional Office : Chennai.



Certificate of Merit

This is to certify that Selvi / Selvan K. Muthilan
of Chikkanna Govt Arts College, Tiruppur
has participated in the Inter College Quiz competition conducted as a part of Exhibition on
UNsung FREEDOM FIGHTERS and CENTRAL GOVERNMENT WELFARE SCHEMES held at Coimbatore
on 21.03.2023





இளைஞர் நலன் மற்றும் விளையாட்டு மேம்பாட்டுத்துறை
தமிழ்நாடு விளையாட்டு மேம்பாட்டு ஆணையம்
முதலமைச்சர் கோப்பை

மாவட்ட அளவிலான விளையாட்டுப் போட்டிகள் 2022 - 2023

பாராட்டுச் சான்றிதழ்

திருமிகு சன்னி பிரியா G அவர்கள் 09.02.2023 அன்று நடைபெற்ற
வகைகோல்பந்து போட்டியில் கல்லூரி பிரிவில் பங்கேற்று வெள்ளி பதக்கம்
வென்றதைப் பாராட்டி இச்சான்றிதழ் வழங்கப்படுகிறது.

மாவட்ட விளையாட்டு அலுவலர்
திருப்பூர் மாவட்டம்

மாவட்ட ஆட்சித்தலைவர்
திருப்பூர் மாவட்டம்



இளைஞர் நலன் மற்றும் விளையாட்டு மேம்பாட்டுத்துறை
தமிழ்நாடு விளையாட்டு மேம்பாட்டு ஆணையம்
முதலமைச்சர் கோப்பை

மாவட்ட அளவிலான விளையாட்டுப் போட்டிகள் 2022 - 2023

பாராட்டுச் சான்றிதழ்

திருமிகு சுரேஷ் V அவர்கள் 09.02.2023 அன்று நடைபெற்ற
வகைகோல்பந்து போட்டியில் கல்லூரி பிரிவில் பங்கேற்று வெள்ளி பதக்கம்
வென்றதைப் பாராட்டி இச்சான்றிதழ் வழங்கப்படுகிறது.

மாவட்ட விளையாட்டு அலுவலர்
திருப்பூர் மாவட்டம்

மாவட்ட ஆட்சித்தலைவர்
திருப்பூர் மாவட்டம்





இளைஞர் நலன் மற்றும் விளையாட்டு மேம்பாட்டுத்துறை
தமிழ்நாடு விளையாட்டு மேம்பாட்டு ஆணையம்
முதலமைச்சர் கோப்பை

மாவட்ட அளவிலான விளையாட்டுப் போட்டிகள் 2022 - 2023

பாராட்டுச் சான்றிதழ்

திருமிகு ஷாலினி S அவர்கள் 09.02.2023 அன்று நடைபெற்ற
வலைகோல்பந்து போட்டியில் கலிஹாசிப் பிரிவில் பங்கேற்று வெள்ளி பதக்கம்
வென்றதைப் பாராட்டி இச்சான்றிதழ் வழங்கப்படுகிறது.

டி.சி.சுந்தரவேணி
மாவட்ட விளையாட்டு அலுவலர்
திருப்பூர் மாவட்டம்

டி.சி.சுந்தரவேணி
மாவட்ட ஆட்சித்தலைவர்
திருப்பூர் மாவட்டம்



இளைஞர் நலன் மற்றும் விளையாட்டு மேம்பாட்டுத்துறை
தமிழ்நாடு விளையாட்டு மேம்பாட்டு ஆணையம்
முதலமைச்சர் கோப்பை

மாவட்ட அளவிலான விளையாட்டுப் போட்டிகள் 2022 - 2023

பாராட்டுச் சான்றிதழ்

திருமிகு திருஷா T அவர்கள் 09.02.2023 அன்று நடைபெற்ற
வலைகோல்பந்து போட்டியில் கலிஹாசிப் பிரிவில் பங்கேற்று வெள்ளி பதக்கம்
வென்றதைப் பாராட்டி இச்சான்றிதழ் வழங்கப்படுகிறது.

டி.சி.சுந்தரவேணி
மாவட்ட விளையாட்டு அலுவலர்
திருப்பூர் மாவட்டம்

டி.சி.சுந்தரவேணி
மாவட்ட ஆட்சித்தலைவர்
திருப்பூர் மாவட்டம்



TRP/HK - FIC/2



இளைஞர் நலன் மற்றும் விளையாட்டு மேம்பாட்டுத்துறை
தமிழ்நாடு விளையாட்டு மேம்பாட்டு ஆணையம்
முதலமைச்சர் கோப்பை

மாவட்ட அளவிலான விளையாட்டுப் போட்டிகள் 2022 - 2023

பாராட்டுச் சான்றிதழ்

திருமிகு நீஷானா S அவர்கள் 09.02.2023 அன்று நடைபெற்ற
வலைகோல்பந்து போட்டியில் கல்சூரிப் பிரிவில் பங்கேற்று வெள்ளிப் பதக்கம்
வென்றதைப் பாராட்டி இச்சான்றிதழ் வழங்கப்படுகிறது.

செ.கே.செல்வம்
மாவட்ட விளையாட்டு அலுவலர்
கிழப்பூர் மாவட்டம்

சு.சி.சித்தலைவர்
மாவட்ட ஆட்சித்தலைவர்
கிழப்பூர் மாவட்டம்



இளைஞர் நலன் மற்றும் விளையாட்டு மேம்பாட்டுத்துறை
தமிழ்நாடு விளையாட்டு மேம்பாட்டு ஆணையம்
முதலமைச்சர் கோப்பை

மாவட்ட அளவிலான விளையாட்டுப் போட்டிகள் 2022 - 2023

பாராட்டுச் சான்றிதழ்

திருமிகு அகல்யா P அவர்கள் 09.02.2023 அன்று நடைபெற்ற
வலைகோல்பந்து போட்டியில் கல்சூரிப் பிரிவில் பங்கேற்று வெள்ளிப் பதக்கம்
வென்றதைப் பாராட்டி இச்சான்றிதழ் வழங்கப்படுகிறது.

செ.கே.செல்வம்
மாவட்ட விளையாட்டு அலுவலர்
கிழப்பூர் மாவட்டம்

சு.சி.சித்தலைவர்
மாவட்ட ஆட்சித்தலைவர்
கிழப்பூர் மாவட்டம்



TRP/HK - F/C/2



இளைஞர் நலன் மற்றும் விளையாட்டு மேம்பாட்டுத்துறை
தமிழ்நாடு விளையாட்டு மேம்பாட்டு ஆணையம்
முதலமைச்சர் கோப்பை

மாஸ்ட. அளவிலான விளையாட்டுப் போட்டிகள் 2022 - 2023

பாராட்டுச் சான்றிதழ்

திருமிகு அன்தா R அவர்கள் 15.02.2023 அன்று நடைபெற்ற
கால்பந்து போட்டியில் கல்ஹரி பிரிவில் பங்கேற்று வென்சிப் பதக்கம்
வென்றதைப் பாராட்டி இச்சான்றிதழ் வழங்கப்படுகிறது.

ச. சித்தலட்சுமி
மாஸ்ட. விளையாட்டு அலுவலர்
கிழப்பூர் மாஸ்ட.ம்

ச. சித்தலட்சுமி
மாஸ்ட. ஆட்சித்தலைவர்
கிழப்பூர் மாஸ்ட.ம்



இளைஞர் நலன் மற்றும் விளையாட்டு மேம்பாட்டுத்துறை
தமிழ்நாடு விளையாட்டு மேம்பாட்டு ஆணையம்
முதலமைச்சர் கோப்பை

மாஸ்ட. அளவிலான விளையாட்டுப் போட்டிகள் 2022 - 2023

பாராட்டுச் சான்றிதழ்

திருமிகு சேணுகா V அவர்கள் 15.02.2023 அன்று நடைபெற்ற
கால்பந்து போட்டியில் கல்ஹரி பிரிவில் பங்கேற்று வென்சிப் பதக்கம்
வென்றதைப் பாராட்டி இச்சான்றிதழ் வழங்கப்படுகிறது.

ச. சித்தலட்சுமி
மாஸ்ட. விளையாட்டு அலுவலர்
கிழப்பூர் மாஸ்ட.ம்

ச. சித்தலட்சுமி
மாஸ்ட. ஆட்சித்தலைவர்
கிழப்பூர் மாஸ்ட.ம்





இளைஞர் நலன் மற்றும் விளையாட்டு மேம்பாட்டுத்துறை
தமிழ்நாடு விளையாட்டு மேம்பாட்டு ஆணையம்
முதலமைச்சர் கோப்பை
மாவுட்ட அளவினை விளையாட்டுப் போட்டிகள் 2022 - 2023

பாராட்டுச் சான்றிதழ்

திருமிகு ஷால்னி S அவர்கள் 15.02.2023 அன்று நடைபெற்ற
கால்பந்து போட்டியில் கல்யாணி பிரிவில் பங்கேற்று வெள்ளி பதக்கம்
வென்றதைப் பாராட்டி இச்சான்றிதழ் வழங்கப்படுகிறது.

ச. சிவசுப்பிரமணியன்
மாவுட்ட விளையாட்டு அலுவலர்

ச. சிவசுப்பிரமணியன்
மாவுட்ட ஆட்சித்தலைவர்
கிழப்பூர் மாவுட்டம்



TAF/FS-FC/12



இளைஞர் நலன் மற்றும் விளையாட்டு மேம்பாட்டுத்துறை
தமிழ்நாடு விளையாட்டு மேம்பாட்டு ஆணையம்
முதலமைச்சர் கோப்பை
மாவுட்ட அளவினை விளையாட்டுப் போட்டிகள் 2022 - 2023

பாராட்டுச் சான்றிதழ்

திருமிகு தீர்ஷா T அவர்கள் 15.02.2023 அன்று நடைபெற்ற
கால்பந்து போட்டியில் கல்யாணி பிரிவில் பங்கேற்று வெள்ளி பதக்கம்
வென்றதைப் பாராட்டி இச்சான்றிதழ் வழங்கப்படுகிறது.

ச. சிவசுப்பிரமணியன்
மாவுட்ட விளையாட்டு அலுவலர்
கிழப்பூர் மாவுட்டம்

ச. சிவசுப்பிரமணியன்
மாவுட்ட ஆட்சித்தலைவர்
கிழப்பூர் மாவுட்டம்





இளைஞர் நலன் மற்றும் விளையாட்டு மேம்பாட்டுத்துறை
தமிழ்நாடு விளையாட்டு மேம்பாட்டு ஆணையம்
முதலமைச்சர் கோப்பை

மாஸ்ட். அளவீசன விளையாட்டுப் போட்டிகள் 2022 - 2023

பாராட்டுச் சான்றிதழ்

திருமிகு நீலாணா S அவர்கள் 15.02.2023 அன்று நடைபெற்ற
கால்பந்து போட்டியில் கல்னாரிப் பிரிவில் பங்கேற்று வெள்ளிப் பதக்கம்
வென்றதைப் பாராட்டி இச்சான்றிதழ் வழங்கப்படுகிறது.

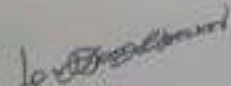
மாஸ்ட். விளையாட்டு அலுவலர்
கிழப்பூர் மாஸ்டம்

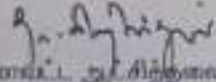
மாஸ்ட். அட்சித்தலலவர்
கிழப்பூர் மாஸ்டம்



இளைஞர் நலன் மற்றும் விளையாட்டு மேம்பாட்டுத்துறை
தமிழ்நாடு விளையாட்டு மேம்பாட்டு ஆணையம்
முதலமைச்சர் கோப்பை

மாஸ்ட். அளவீசன விளையாட்டுப் போட்டிகள் 2022 - 2023

பாராட்டுச் சான்றிதழ்

திருமிகு அகல்யா P அவர்கள் 15.02.2023 அன்று நடைபெற்ற
கால்பந்து போட்டியில் கல்னாரிப் பிரிவில் பங்கேற்று வெள்ளிப் பதக்கம்
வென்றதைப் பாராட்டி இச்சான்றிதழ் வழங்கப்படுகிறது.

மாஸ்ட். விளையாட்டு அலுவலர்
கிழப்பூர் மாஸ்டம்

மாஸ்ட். அட்சித்தலலவர்
கிழப்பூர் மாஸ்டம்



TROPHIES - F1/L12

BHARATHIAR UNIVERSITY



COIMBATORE - 641 046,

C.No. 1374

INTER-COLLEGIATE TOURNAMENTS

2022 - 2023

CERTIFICATE OF MERIT

Name : S. ARGATHIYAN
Institution : CHIKKANNA GOVT ARTS COLLEGE
Degree : M. SC (MATHS) Year II Date of Birth 01-06-2001
Event : HOCKEY
Place : RUNNER-UP
Performance : _____ Date : 09-11-2022

Director of Physical Education i/c

N. Jayakumar
Vice - Chancellor Committee

BHARATHIAR UNIVERSITY



COIMBATORE - 641 046,

C.No. 1359

INTER-COLLEGIATE TOURNAMENTS

2022 - 2023

CERTIFICATE OF MERIT

Name : S. JEEVA
Institution : CHIKKANNA GOVT ARTS COLLEGE
Degree : MA (TAMIL) Year I Date of Birth _____
Event : HOCKEY
Place : RUNNER-UP
Performance : _____ Date : 09.11.2022

ajaneey
Director of Physical Education i/c

N. Jayakumar
Vice - Chancellor Committee

BHARATHIAR UNIVERSITY



COIMBATORE - 641 046.

C.No. 1360

INTER-COLLEGIATE TOURNAMENTS

2022 - 2023

CERTIFICATE OF MERIT

Name : S. DRAYUSH
Institution : CHIKKANNA GOVT ARTS COLLEGE
Degree : BBA Year : III Date of Birth : 24.06.2003
Event : HOCKEY
Place : RUNNER-UP
Performance : _____ Date : 09.11.2022

agency
Director of Physical Education i/c

N. Jayalaxmi
Vice-Chancellor Committee

BHARATHIAR UNIVERSITY



COIMBATORE - 641 046.

C.No. 1361

INTER-COLLEGIATE TOURNAMENTS

2022 - 2023

CERTIFICATE OF MERIT

Name : S. SURENTHARAN
Institution : CHIKKANNA GOVT ARTS COLLEGE
Degree : B.Com Year : III Date of Birth : 22.07.2003
Event : HOCKEY
Place : RUNNER-UP
Performance : _____ Date : 09.11.2022

agency
Director of Physical Education i/c

N. Jayalaxmi
Vice-Chancellor Committee

BHARATHIAR UNIVERSITY

COIMBATORE - 541 046.

C.No. 1362

INTER-COLLEGIATE TOURNAMENTS

2022 - 2023

CERTIFICATE OF MERIT

Name : S. MALARAVAN
Institution : CHIKRANTA GOVT ARTS COLLEGE
Degree : B.Com Year II Date of Birth 11.01.2004
Event : HOCKEY
Place : RUNNER-UP
Performance : Date: 09.11.2022.

S. Srinivas
Director of Physical Education i/c

N. Jayakumar
Vice - Chancellor Committee

BHARATHIAR UNIVERSITY

COIMBATORE - 641 046.

C.No. 1363

INTER-COLLEGIATE TOURNAMENTS

2022 - 2023

CERTIFICATE OF MERIT

Name : G. SHANMUGANATHAN
Institution : CHIKRANTA GOVT ARTS COLLEGE
Degree : B.Com Year II Date of Birth 20.06.2004
Event : HOCKEY
Place : RUNNER-UP
Performance : Date: 09.11.2022.

S. Srinivas
Director of Physical Education i/c

N. Jayakumar
Vice - Chancellor Committee

BHARATHIAR



UNIVERSITY

COIMBATORE - 641 046.

C.No. 1364

INTER-COLLEGIATE TOURNAMENTS

2022 - 2023

CERTIFICATE OF MERIT

Name : S. SURIYA PRAKASH
Institution : CHIKKANNA GOVT ARTS COLLEGE
Degree : BA (HISTORY) Year : II Date of Birth 25.11.2003.
Event : HOCKEY
Place : RUNNER-UP
Performance : _____ Date : 09.11.2022.

D. Suresh
Director of Physical Education /c

N. Jayakumar
Vice-Chancellor Committee

BHARATHIAR



UNIVERSITY

COIMBATORE - 641 046.

C.No. 1365

INTER-COLLEGIATE TOURNAMENTS

2022 - 2023

CERTIFICATE OF MERIT

Name : A. AKASH
Institution : CHIKKANNA GOVT ARTS COLLEGE
Degree : BCA Year : I Date of Birth 20.11.2004.
Event : HOCKEY
Place : RUNNER-UP
Performance : _____ Date : 09.11.2022.

D. Suresh
Director of Physical Education /c

N. Jayakumar
Vice-Chancellor Committee

BHARATHIAR UNIVERSITY



COIMBATORE - 641 046.

C.No. 1366

INTER-COLLEGIATE TOURNAMENTS

2022 - 2023

CERTIFICATE OF MERIT

Name : G. MANO KANDAN
Institution : CHIKKANA GOVT ARTS COLLEGE
Degree : B.COM Year : I Date of Birth : 15.02.2005
Event : HOCKEY
Place : RUNNER-UP
Performance : _____ Date : 09.11.2022.

Signature
Director of Physical Education i/c

Signature
Vice - Chancellor Committee

BHARATHIAR UNIVERSITY



COIMBATORE - 641 046.

C.No. 1367

INTER-COLLEGIATE TOURNAMENTS

2022 - 2023

CERTIFICATE OF MERIT

Name : S. PRASHAKARAN.
Institution : CHIKKANA GOVT ARTS COLLEGE
Degree : B.COM Year : I Date of Birth : 21.05.2002
Event : HOCKEY
Place : RUNNER-UP
Performance : _____ Date : 09.11.2022.

Signature
Director of Physical Education i/c

Signature
Vice - Chancellor Committee

BHARATHIAR UNIVERSITY



COIMBATORE - 641 046.

C.No. 1368

INTER-COLLEGIATE TOURNAMENTS

2022 - 2023

CERTIFICATE OF MERIT

Name : T. SINGA PRABASH
Institution : CHIKKANNA GOVT ARTS COLLEGE
Degree : B.COM Year : I Date of Birth : 11.02.2005
Event : HOCKEY
Place : RUNNER-UP
Performance : _____ Date : 09.11.2022.

aprasa

Director of Physical Education i/c

N. Jayakumar

Vice - Chancellor Committee

BHARATHIAR UNIVERSITY



COIMBATORE - 641 046.

C.No. 1369

INTER-COLLEGIATE TOURNAMENTS

2022 - 2023

CERTIFICATE OF MERIT

Name : M. SURYA
Institution : CHIKKANNA GOVT ARTS COLLEGE
Degree : B.COM (CA) Year : I Date of Birth : 23.01.2005.
Event : HOCKEY
Place : RUNNER-UP
Performance : _____ Date : 09.11.2022.

aprasa

Director of Physical Education i/c

N. Jayakumar

Vice - Chancellor Committee

BHARATHIAR UNIVERSITY

COIMBATORE - 641 046.

C.No. 1370

INTER-COLLEGIATE TOURNAMENTS

2022 - 2023

CERTIFICATE OF MERIT

Name : M. KARTHEESWARAN
Institution : CHIKKANNA GOVT ARTS COLLEGE
Degree : B.Com (IS) Year : I Date of Birth : 19.12.2003.
Event : Hockey
Place : RUNNER-UP
Performance : _____ Date : 09.11.2022.

Signature
Director of Physical Education i/c.

Signature
Vice - Chancellor Committee

BHARATHIAR UNIVERSITY

COIMBATORE - 641 046.

C.No. 1371

INTER-COLLEGIATE TOURNAMENTS

2022 - 2023

CERTIFICATE OF MERIT

Name : S. SATHEESWARAN
Institution : CHIKKANNA GOVT ARTS COLLEGE
Degree : BBA Year : I Date of Birth : 22.01.2005.
Event : Hockey
Place : RUNNER-UP
Performance : _____ Date : 09.11.2022.

Signature
Director of Physical Education i/c.

Signature
Vice - Chancellor Committee

BHARATHIAR UNIVERSITY

COIMBATORE - 641 046.

C.No. 1372

INTER-COLLEGIATE TOURNAMENTS

2022 - 2023

CERTIFICATE OF MERIT

Name : R. HARIHARAN
Institution : CHIKKANNA GOVT ARTS COLLEGE
Degree : B.Com Year I Date of Birth 21.06.2004
Event : HOCKEY
Place : RUNNER-UP
Performance : _____ Date : 21.06.2024

Signature
Director of Physical Education /c.

Signature
Vice - Chancellor Committee

BHARATHIAR UNIVERSITY

COIMBATORE - 641 046.

C.No. 1358

INTER-COLLEGIATE TOURNAMENTS

20 - 20

CERTIFICATE OF MERIT

Name : V. SELVA KUMAR
Institution : CHIKKANNA GOVT ARTS COLLEGE
Degree : M.Sc (Physics) Year II Date of Birth 20.09.2002
Event : HOCKEY
Place : RUNNER-UP
Performance : _____ Date : 18.10.2022

Signature
Director of Physical Education /c.

Signature
Vice - Chancellor Committee

FORM-3

S.No. 3514

(For Representing a University in the Inter - University Competition of the Recognized Games / Sports)

BHARATHIAR UNIVERSITY - COIMBATORE - 641 046

 Certificate to a meritorious..... HOCKEY

Sportsman for employment to a Class III Service under Central Government.

 Certified that Shri..... V. SELVAKUMAR..... Son / Daugh

 of Shri..... C. VENKATACHALAM..... resident of 2/145, MEEBHARAN
PALAYAM, VEMANZAM PALAYAM, ERODE

 student of..... CHIKKANNA HOYT ARTS COLLEGE, TIRUPUR

 represented the Bharathiar University in the Game / Event of..... HOCKEY

Participated in the South Zone / All India Inter University Tournament / Athletic Meet / In

 at..... BANGALORE, KARNATAKA..... Organized by the..... BANGALORE CITY UNIVER
BANGALORE, KARNATAKA..... for the year..... 2022, 2023

 from..... 11.12.2022..... to..... 16.12.2022

 The Position obtained by the individual / team in the above said competition - tournament was..... -NIL-

 The Certificate is being given on the basis of records available in the office of the Director
 Physical Education in the **BHARATHIAR UNIVERSITY.**

Place : Coimbatore

Date : 14.09.2023

Name of the University and Address :

Signature : Dr. S.T.N. Rajeswaran, Ph.D.Name : Dr. S.T.N. Rajeswaran, Ph.D.
 Designation : Director of Physical Education in
 Bharathiar University,
 Coimbatore - 641 046.

Seal :

BHARATHIAR UNIVERSITY
COIMBATORE- 641 046.
TAMILNADU

 Note : This Certificate will be valid only when Signed personally by the Registrar / Dean / Director of Physical Education or other officer in overall charges of sports in the **Bharathiar University.**

FORM - 3

S.No. 3175

(For Recognizing a University in the Inter - University Competition of the Recognized Games / Sports)



BHARATHIAR UNIVERSITY - COIMBATORE - 641 046

Competitor to a meritorious _____

HOCKEY

Sportsperson for employment to a Class III Service under Central Government.

Category of the _____

ASHWINKUMAR R

_____, Son / Daughter

of the _____

PENSASAMY A

resident of _____

54/31, KUDGARAN STREET,

RAJAPALAYAM, VEUDHUNAGAR, TAMILNADU

student of CHIRAKANNA GOVERNMENT ARTS COLLEGE, TIRUPUR

represented the Bharathiar University in the Game / Event of _____

HOCKEY

Participated in the South Zone / All India Inter University Tournament / Athletic Meet / held

at BANGALORE, KARNATAKA

Organized by the _____

BANGALORE CITY UNIVERSITY,

BANGALORE, KARNATAKA

for the year 2022 - 2023

from 11.12.2022

to 16.12.2022

The Position obtained by the individual / team in the above said competition - tournament was -NIL-

The Certificate is being given on the basis of records available in the office of the Director of Physical Education in the **BHARATHIAR UNIVERSITY**.

Place : Coimbatore

Signature : _____

28.06.2023

Date : 28.06.2023

Name : _____

Dr. S.T.N. Rajeswaran, Ph.D.

Director of Physical Education in

Name of the University and Address :

Designation : _____

Bharathiar University,
Coimbatore - 641 046

Seal :



BHARATHIAR UNIVERSITY
COIMBATORE- 641 046.
TAMILNADU

Note : This Certificate will be valid only when signed personally by the Registrar / Dean / Director of Physical Education or other officer in overall charges of sports in the **Bharathiar University**.

FORM - 3

S.No. 3545

(For Representing a University in the Inter - University Competition of the Recognized Games / Sports)



BHARATHIAR UNIVERSITY - COIMBATORE - 641 046



Certified that a meritorious..... HOCKEY.....

Sportsman for employment in a Class III Service under Central Government.

Certified that Shri..... A. AKASH.....

Son / Daughter

of Shri..... S. ARUL DASS..... resident of..... 13, Pookkara Muslim
Street, Chandavur.....

student of..... CHIKKANNA GOVT ARTS COLLEGE, TIRUPUR.....

represented the Bharathiar University in the Game / Event of..... HOCKEY.....

Participated in the South Zone / All India Inter University Tournament / Athletic Meet / held
at..... BANGALORE, KARNATAKA..... Organized by the..... BANGALORE CITY UNIVERSITY
BANGALORE, KARNATAKA.....

for the year..... 2022-2023.....

from..... 11.12.2022..... to..... 16.12.2022.....

The Position obtained by the individual / team in the above said competition - tournament was..... NIL.....

The Certificate is being given on the basis of records available in the office of the Director of Physical Education in the **BHARATHIAR UNIVERSITY**.

Place : Coimbatore

Date: 14.09.2023

Name of the University and Address :

Signature : [Signature] 14.09.2023

Dr. S.T.N. Rajeswaran, Ph.D.,

Name : Director of Physical Education &
Bharathiar University,
Coimbatore - 641 046.

Designation :

Seal :



BHARATHIAR UNIVERSITY
COIMBATORE- 641 046,
TAMILNADU

Note : This Certificate will be valid only when Signed personally by the Registrar / Dean / Director of Physical Education or other officer in overall charges of sports in the **Bharathiar University**.

(For Representing a University in the Inter - University Competition of the Recognized Games / Sports)

BHARATHIAR UNIVERSITY - COIMBATORE - 641 046

 Competitor's territoriality: HOCKEY

Sportsman for employment in Class III Service under Central Government.

Certified that Shri S. SURIYA PRABACH Son / Daughter
 of Shri M. SUBRAMANIAN resident of 2/46, KALAMMAN KOVI
STREET, M. SANKERALINGAPURAM, VIRUDHUNAGAR
 student of CHIKKANNA GOVT ARTS COLLEGE, TIRUPUR
 represented the Bharathiar University in the Game / Event of HOCKEY
 Participated in the South Zone / All India Inter University Tournament / Athletic Meets / held
 at BANGALORE, KARNATAKA Organized by the BANGALORE CITY UNIVERSITY
BANGALORE, KARNATAKA for the year 2022-2023
 from 11.12.2022 to 16.12.2022

 The Position obtained by the individual / team in the above said competition - tournament was: NIL

 The Certificate is being given on the basis of records available in the office of the Director of Physical Education in the **BHARATHIAR UNIVERSITY**.

Place : Coimbatore

Signature :

Dr. S.T.N. Rajeswaran, Ph.D.
Date : 14.09.2023

Name :

 Director of Physical Education /
 Bharathiar University,
 Coimbatore - 641 046.

Name of the University and Address :

Designation :

Seal :

BHARATHIAR UNIVERSITY
 COIMBATORE- 641 046.
 TAMILNADU

Note : This Certificate will be valid only when Signed personally by the Registrar / Dean / Director of Physical Education or other officer in overall charges of sports in the Bharathiar University.



TIRUPUR DISTRICT AMATEUR BODY BUILDING ASSOCIATION



Tamilnadu Societies Registration act 1975 Reg No.35

Affiliated To: Tamilnadu Amateur Bodybuilding Association .Chennai

Recognized By: Indian Body Builders Federation Mumbai.

Government of India Ministry of youth affairs & Sports New Delhi

Sports Development Authority of Tamilnadu, Tamilnadu Olympic Association



Organized by :

TIRUPUR DISTRICT AMATEUR BODY BUILDING ASSOCIATION



This is to Certify that Mr. S.DINESH KUMAR of

GOLD GYM Gym has Secured Ist Place in 55 Kg

Category In Tirupur District Level Senior / Master's Body Building / Men's Physique Championship 2022. Held at

HARVEE KUMARASAMY KALYANAMANDAPAM, Tirupur on 18.08.2022.

President
TDABBA

Chief Judge
TDABBA

Secretary
TDABBA

34th TAMILNADU STATE TAEKWONDO CHAMPIONSHIPS - 2023



Organized by
SPORTS TAEKWONDO ASSOCIATION OF THIRUVARUR DISTRICT
31109 - B, Keela street, Vilamai, Thiruvavarur-610004.

Promoted by
TAMILNADU TAEKWONDO ASSOCIATION
646/6, Govindasamy Street, Vanniyar Nagar, Periyapudur, Salem-636016.

Affiliated to : TAEKWONDO FEDERATION OF INDIA
: TAMILNADU STATE OLYMPIC ASSOCIATION
Recognised by : SPORTS DEVELOPMENT AUTHORITY OF TAMILNADU
: MINISTRY OF YOUTH AFFAIRS & SPORTS, GOVT. OF INDIA



No. TNTA/2023/34S/SR-F-K/P-142

This is to certify that Ms. AGALYA .P of TIRUPPUR, has participated as COMPETITOR in SENIOR GIRLS – UNDER 46kg weight category in the Championships held from 29th June to 02nd July 2023 at Central University of Tamil Nadu, Thiruvavarur District.

R. BALASANKAR, 3rd Dan,
WT Asia Coach License Holder,
Organizing Secretary,
General Secretary, Sports Taekwondo
Association of Thiruvavarur District

M.R. NANDAGOPAL, BBA,
Organizing President,
President,
Sports Taekwondo
Association of Thiruvavarur District

P. SELVAMANI, 3rd Dan
International Referee,
General Secretary, TNTA,
Chairman, Technical Committee/ITF
EC Member, Tamil Nadu State Olympic Assn.

Dr. ISHARI K.GANESH,
Honorary, Vels University
President, Tamil Nadu Taekwondo Association,
President, Taekwondo Federation of India,
President, Tamil Nadu State Olympic Association.

தமிழ்நாடு தேக்வாண்டோ சங்கம் (பதிவு)
TAMIL NADU TAEKWONDO ASSOCIATION

Contact Address : No. 646M, Govindasamy Street, Vanniyar Nagar, Periyapudhur, SALEM - 636 016.

Affiliated to:
TAMILNADU STATE OLYMPIC ASSOCIATION

web : www.tnta.org.in

Incorporated by:
SPORTS DEVELOPMENT AUTHORITY OF TAMILNADU



COLOUR BELT CERTIFICATE

No.: 7951

This is to certify that

P. AGALYA

having succeeded in the requisite examination, has been granted

~~WHITE 1, YELLOW GREEN BLUE~~

RED BELT *A^{1/2} grade by the reviewing Technical Committee of the Association, this 17th day of Sep 2023*

태권도



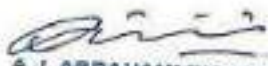

A.J. ABRAHAM LINCOLN
GENERAL SECRETARY
TIRUPPUR DISTRICT TAEKWONDO ASSOCIATION
24 MOOREGAI NAGAR 2nd STREET TIRUPPUR - 617002
CELL No.: 9541061199

Association.



Grand Master P. SELVAMANI, M.A.
7th Dan Black Belt, (Kukkiwon, Korea)
International Referee
General Secretary & Chief Technical Director,
TAMILNADU TAEKWONDO ASSOCIATION.

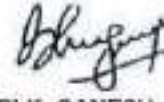

Dr. ISHARI K. GANESH, M.COM, M.B.A., B.L., PH.D.
(Founder - Chancellor, VELS University, Chennai.)

President

TAMILNADU TAEKWONDO ASSOCIATION.



TIRUPUR ATHLETIC ASSOCIATION

"In Service - Beyond Limits - In Memory - United Goals"
Affiliated by Tamil Nadu Athletic Association

Conducts



MOHAN KANDASAMY MEMORIAL

5th TIRUPUR DISTRICT JUNIOR ATHLETIC CHAMPIONSHIP - 2023

Certificate of Merit

Name : **AGALYA P**
Institution/Club : **BORN TO RUN SPORTS ACADEMY**
D.O.B : **15-03-2005** Category : **GIRLS 20**
Event : **LONG JUMP** Position : **SECOND**
Performance : **3.94M**
Venue : **T.E.A Public Mat Hr Sec School, Avinashi.** Date : **13-08-2023**



PRESIDENT
TIRUPUR ATHLETIC ASSOCIATION



SECRETARY
TIRUPUR ATHLETIC ASSOCIATION

oprah...
TECHNICAL COMMITTEE CHAIRMAN
TIRUPUR ATHLETIC ASSOCIATION



ORGANIZING SECRETARY
JUNIOR ATHLETIC CHAMPIONSHIP



8th TIRUPPUR DISTRICT TAEKWONDO CHAMPIONSHIP 2023-2024

태
권
도

태
권
도

Organized by
Tiruppur District Taekwondo Association

Promoted by
Tamilnadu Taekwondo Association

Affiliated to
Taekwondo Federation Of India
Tamilnadu State Olympic Association

Recognised by
Sports Development Authority Of Tamilnadu
Ministry of Youth Affairs and Sports Government of India

CERTIFICATE OF MERIT

This is to certify that Miss/Mr. P. AGALYA of
CHIKKANA COLLEGE has participated as a Competitor /
Official / Referee in the TAEKWONDO Championship held on 25th June 2023
at MN. Chikkanna Chettiar Matriculation School, Palayakkadu, Uthukuli
Road, Tiruppur and is awarded GOLD medal in
SENIOR GIRLS, U-46 kg. Height/Weight Category.

M. Muthu Kumar
.....
M.MUTHU KUMAR
Organizing President & President -
Tiruppur District Taekwondo Association,
Chairman -
Tiruppur Taekwondo Sports Club

A. J. Abraham Lincoln
.....
A.J.ABRAHAMLINCOLN 4th DAN
National Referee,
Organizing Secretary & Secretary -
Tiruppur District Taekwondo Association,
Executive Committee Member -
Tamilnadu Taekwondo Association.

P. Selvamani M.A.
.....
P.SELVAMANI M.A., 7th DAN
International Referee,
General Secretary & Chief Technical Director -
Tamilnadu Taekwondo Association,
Executive Committee Member -
Tamilnadu State Olympic Association,
Chairman - Technical Committee - TFI



SG MASTER
 ☆☆☆☆ **8th SG Star Award** ☆☆☆☆
Ooty National Taekwondo Championship 2022
 Organized by SG Master Taekwondo Centre ®
CERTIFICATE OF MERIT

This Certificate is awarded to

P. Agalya – Gold (Kyorugi)

For showing exemplary performance in Kyorugi / Poomsae held on 7th & 8th January 2022 at Ooty.

ORGANISER

Suresh .S
 International Team Coach, National Referee
 S.G. Master Taekwondo Centre (R)
 President

Reg. No. :UP/510/83-142/1073

FORM-2

Serial No. SGADF/RI/



(For representing a state of India in a National Championship in one of the Games/Sports)

**SCHOOL GAMES AND ACTIVITY
DEVELOPMENT FOUNDATION**

04, Shri Ram Plaza, Jalpura, Sec-01 Greater Noida-West (G.B Nagar)
Uttar Pradesh-INDIA - Pin-201306



Certificate to a meritorious C Sportsman for
Employment to Group 'C' and 'D' Services under the Central Government.

Certificate that Sh./smt./km. VASUKI DEVI. T Son/Daughter of Shri
THIRUPATHI S resident of TIRUPPUR

represented the State of TAMIL NADU in CHESS game /event of
NATIONAL CHESS in the National Championship
held at SODI STADIUM TIRUPPUR TAMIL NADU
from 26/11/2021 to 28/11/2021.

The Position obtained by the CHESS individual in the above said
Competition /Tournament was T

The Certificate is being given on the basis of record available in the office of the
SCHOOL GAMES AND ACTIVITY DEVELOPMENT FOUNDATION.

Place : TIRUPPUR

Date : 26.11.2021



Signature

[Handwritten Signature]

Name

Shivani Thakur

Designation

President

Address

04, Shri ram Plaza Jalpura
Sec-01 West Greater Noida
Gautam Buddha Nagar,
Uttar Pradesh Pin-201306,

Seal

Note : This Certificate will be valid only when signed personally in the presence of President of Foundation



(For representing a state of India in a National Championship in one of the Games/Sports)

SCHOOL GAMES AND ACTIVITY DEVELOPMENT FOUNDATION04, Shri Ram Plaza, Jalpura, Sec-01 Greater Noida-West (G.B Nagar)
Uttar Pradesh- INDIA - Pin-201306

Certificate to a meritorious C Sportsman for
Employment to Group 'C' and 'D' Services under the Central Government.

Certificate that Sh./smt./km. MOHAMED BRAHIM A Son/Daughter of Shri
AMSHA MOHAMED M resident of TIRUPPUR

represented the State of TAMIL NADU in CHESS game /event of
NATIONAL CHESS in the National Championship
held at SDA7 STADIUM TIRUPPUR TAMIL NADU
from 24/11/2021 to 28/11/2021.

The Position obtained by the CHESS individual in the above said
Competition/Tournament was I

The Certificate is being given on the basis of record available in the office of the
SCHOOL GAMES AND ACTIVITY DEVELOPMENT FOUNDATION.

Place : TIRUPPURDate : 24/11/2021

Signature

Name

: Shyam Shankar

Designation

: President

Address

: 04, Shri ram Plaza Jalpura
Sec-01 West Greater Noida
Gautam Buddha Nagar,
Uttar Pradesh Pin-201306

Seal

Note : This Certificate will be valid only when signed personally in the Secretary / President of Organization



Income Tax Department, Tirupur

CERTIFICATE OF APPRECIATION

This Certificate is presented to **SOWMIYA D. S** of **ILMSc CDE, CHIKKANNA GOVT ARTS COLLEGE, TIRUPUR** for participating in the **DRAWING** competition organized on the occasion of Azadi ka Amrit Mahotsav on the theme:

आज़ादी की "Freedom of Thought"
सोच की आजादी
अमृत महोत्सव
and she has been adjudged to **SECOND PRIZE**

Presented on the Day **09th** of **DECEMBER** 2021

A.D. Commissioner of Income Tax
Tirupur



Income Tax Department, Tirupur

CERTIFICATE OF APPRECIATION

This Certificate is presented to **YANISRI S** of **ILMSc CDE, CHIKKANNA GOVT ARTS COLLEGE, TIRUPUR** for participating in the **DRAWING** competition organized on the occasion of Azadi ka Amrit Mahotsav on the theme:

आज़ादी की "Freedom of Thought"
सोच की आजादी
अमृत महोत्सव
and she has been adjudged to **FIRST PRIZE**

Presented on the Day **09th** of **DECEMBER** 2021

A.D. Commissioner of Income Tax
Tirupur



Sr. No. 47584



School Games & Activity Development Foundation



Register Under: Indian Govt. Trust Act, NITI Aayog Govt. of India, MSME- Ministry of Micro Small & Medium Enterprises, Fit India & Nehru Yuva Kendra Sangathan, Affiliated with: International Council for Sports and Activity Federation, Membership By International : ICSSPE-IAS-TAFISA, Organization Certified by : International Organization Standardization ISO 9001: 2015, IAS Partner of : FSN, International Paralympic Committee, German Sports University, ICSSPE Partner of : International Federation of Sports Medicine, International Olympic Committee

FIT INDIA & NYKS Recognised Under MINISTRY OF YOUTH AFFAIRS AND SPORTS GOVERNMENT OF INDIA NATIONAL CHAMPIONSHIP

Certificate of Merit/Participant

This is to Certify that MANIKANDAN..M.....Son/daughter of..MUTHU..KAMPACHI.....Date of Birth .30./01../2002 from School/State/Academy/Organization/CollegeTAMIL NADU..... Participated in National Championship which was held on 26th to 28th November 2021 atSDAT....STADIUM.....TIRUPPUR,.....TAMILNADU..... He/she got .SECOND.....Place in VALLEY BALL...GameEvent in UNDER..21.....Age Category.



Original Certificate Identity

Mr. M. Poovarasan Tam Nadu SQAD/ President

Mr. Shivam Thakur National Member/ President

Mr. Ankit Kumar Vice President

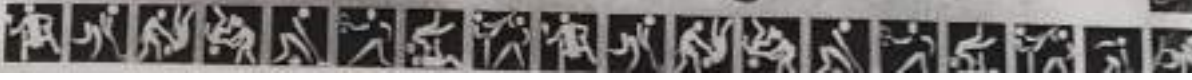
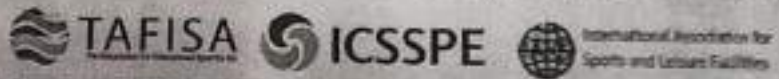

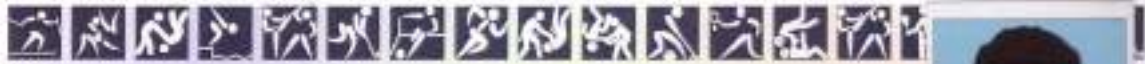

Sr. No.



School Games & Activity Development Foundation

Register Under Indian Govt. Trust Act, NITI Aayog Govt. of India,
 MSME- Ministry of Micro Small & Medium Enterprises,
 Fit India & Nehru Yuva Kendra Sangathan
 Affiliated with: International Council For Sports and Activity Federation
 Membership By International : **ICSSPE-IAKS-TAFISA**
 Organization Certified By : International Organization Standardization ISO 9001: 2015
 IAKS Partner of : FSN, International Paralympic Committee, German Sports University
 ICSSPE Partner of : International Federation of Sports Medicine, International Olympic Committee



MINISTRY OF YOUTH AFFAIRS AND SPORTS GOVERNMENT OF INDIA

NATIONAL CHAMPIONSHIP

Certificate of Merit/Participant

This is to Certify that **SASI KUMAR . . M** Son/daughter
 of **MANI** Date of Birth **23 / 12 / 2001**
 from School/State/Academy/Organization/College
TAMIL NADU
 Participated in **National Championship** which was held on
 26th to 28th November 2021 at **SDAT STADIUM, TIRUPPUR, TAMILNADU**
 He/she got **SECOND** Place in **KABADDI** Game
 Event in **UNDER - 21** Age Category.



M. Poovarasan
 Mr. M. Poovarasan
 Tamilnadu SDACP/ President

Shivam Thakur
 Mr. Shivam Thakur
 National Nardari/ President

Ankit Kumar
 Mr. Ankit Kumar
 VJW/President



Sr. No.



School Games & Activity Development Foundation

Register Under: Indian Govt. Trust Act, NITI Aayog Govt. of India,
 MSME- Ministry of Micro Small & Medium Enterprises,
 Fit India & Nehru Yuva Kendra Sangathan
 Affiliated with International Council for Sports and Activity Federation
Membership By International : ICSSPE IAKS-TAFISA
 Organization Certified By : International Organization Standardization ISO 9001: 2015
 IAKS Partner of : FSN, International Paralympic Committee, German Sports University
 ICSSPE Partner of : International Federation of Sports Medicine, International Olympic Committee



MINISTRY OF YOUTH AFFAIRS AND SPORTS GOVERNMENT OF INDIA

NATIONAL CHAMPIONSHIP

Certificate of Merit/Participant

This is to Certify that..SEENU..T.....Son/daughter
 of.....THENNARASU.....Date of Birth .16../.05./2004
 from School/State/Academy/Organization/College
TAMIL NADU.....
 Participated in **National Championship** which was held on
 26th to 28th November 2021 at
 ...SDAT STADIUM.,TIRUPPUR.,TAMIL NADU.....
 He/she got ...SECOND.....Place in KABADDI.....Game
Event in UNDER : 19.....Age Category.



Original Certificate
Identify

Mr. M. Poovaran
Tamil Nadu SGADF President

Mr. Shivam Thakur
National Member/ President

Mr. Ankit Kumar
Vice-President



TAFISA



ICSSPE



International Association for
Sports and Leisure Facilities

Sr. No.



School Games & Activity Development Foundation



Register Under: Indian Govt. Trust Act, NITI Aayog Govt. of India, MSME - Ministry of Micro Small & Medium Enterprises, Fit India & Nehru Yuva Kendra Sangathan

Affiliated with: International Council for Sports and Activity Federation

Membership By International : ICSSPE-IAKS-TAFISA

Organization Certified By : International Organization Standardization ISO 9001: 2015

IAKS Partner of : FISM, International Paralympic Committee, German Sports University

ICSSPE Partner of : International Federation of Sports Medicine, International Olympic Committee

FIT INDIA & NYKS Recognised Under

MINISTRY OF YOUTH AFFAIRS AND SPORTS GOVERNMENT OF INDIA

NATIONAL CHAMPIONSHIP

Certificate of Merit/Participant

This is to Certify that..SURENDAHAREN:..S.....Son/daughter of.....SEKAR.....Date of Birth ..12./08../2003

from School/State/Academy/Organization/College

.....TAMIL NADU.....

Participated in National Championship which was held on 26th to 28th November 2021 at

...SDAT...STADIUM...TIRUPPUR, TAMIL NADU.....

He/she gotSECOND.....Place in KABADDI.....Game

.....Event in..UNDER..19.....Age Category.



Signature of Mr. M. Poovarasam

Mr. M. Poovarasam Tarehate SGADF President

Signature of Mr. Shivam Thakur

Mr. Shivam Thakur National Member/ President

Signature of Mr. Ankit Kumar

Mr. Ankit Kumar Vice-President



TAFISA



ICSSPE



International Association for Sports and Leisure Facilities

Sr. No.



School Games & Activity Development Foundation

Register Under: Indian Govt. Trust Act, MHA Arjog Govt. of India,
 MSME - Ministry of Micro Small & Medium Enterprises,
 FIT India & Nehru Yuv Krishi Sangathan

Affiliated with International Council for Sports and Activity Federation
Membership By International : ICSSPE-IKS-TAFISA
 Organization Certified By : International Organization Standardization ISO 9001: 2015
 IKS Partner of : FSM, International Paralympic Committee, German Sports University
 ICSSPE Partner of : International Federation of Sports Medicine, International Olympic Committee



FIT INDIA & NYKS Recognised Under

MINISTRY OF YOUTH AFFAIRS AND SPORTS GOVERNMENT OF INDIA

NATIONAL CHAMPIONSHIP

Certificate of Merit/Participant

This is to Certify that.. **ISSAC. AZARIAH. A**.....Son/daughter
 of.. **ABRAHAM. JASHUA**.....Date of Birth **11.../11.../2003**

from School/State/Academy/Organization/College

.....**TAMIL NADU**.....

Participated in **National Championship** which was held on
 26th to 28th November 2021 at

.....**SDAT.....STADIUM, TIRUPPUR, TAMILNADU**.....

He/she got**SECOND**.....Place in **KABADDI**.....Game

.....Event in **UNDER...19**.....Age Category.



Original Certificate
190077

Mr. M. Poovarasan
Tamilnadu SOADFI President

Mr. Shivam Thakur
National Member President

Mr. Ankit Kumar
Vice President



TAFISA



ICSSPE



International Association for
Sports and Leisure Facilities

Sr. No.



School Games & Activity Development Foundation

Registrar Under: Indian Govt. Trust Act, NIT Assam Govt. of India,
NSME- Ministry of Micro Small & Medium Enterprises,
Fit India & Nehru Yuva Kendra Sangathan

Affiliated with: International Council for Sports and Activity Federation

Membership By International : ICSSPE-IAKS-TAFISA

Organization Certified By : International Organization Standardization ISO 9001: 2015

IAKS Partner of : FSI, International Paralympic Committee, German Sports University

ICSSPE Partner of : International Federation of Sports Medicine, International Olympic Committee

FIT INDIA & NYKS Recognised Under

MINISTRY OF YOUTH AFFAIRS AND SPORTS GOVERNMENT OF INDIA

NATIONAL CHAMPIONSHIP

Certificate of Merit/Participant

This is to Certify that **THANU APANDI . S.**.....Son/daughter
of **SUBBIA . I . MUTHU**.....Date of Birth **14 / 04 / 2001**
from School/State/Academy/Organization/College
.....**TAMILNADU**.....

Participated in **National Championship** which was held on
26th to 28th November 2021 at

.....**SAT . STADIUM , TRUPPUR , TAMILNADU**.....

He/she got**SECOND**.....Place in **KABADDI**.....Game
.....**19**.....Age Category.



Original Certificate
Identity

Mr. M. Poovarasam
Executive SGADFI President

Mr. Shivam Thakur
National Member/ President

Mr. Ankit Kumar
Vice-President



TAFISA



ICSSPE



International Association for
Sports and Leisure Facilities



Sr. No.



School Games & Activity Development Foundation

Register Under: Indian Govt. Trust Act, NITI Aayog Govt. of India,
 MSME- Ministry of Micro Small & Medium Enterprises,
 Fit India & Nehru Youth Kendra Sangathan

Affiliated with: International Council for Sports and Activity Federation
Membership By International : ICSSPE-IAS-TAFISA

Organization Certified By : International Organization Standardisation ISO 9001: 2015
 IAS Partner of : FSI, International Paralympic Committee, German Sports University
 ICSSPE Partner of : International Federation of Sports Medicine, International Olympic Committee



FIT INDIA & NYKS Recognised Under

MINISTRY OF YOUTH AFFAIRS AND SPORTS GOVERNMENT OF INDIA

NATIONAL CHAMPIONSHIP

Certificate of Merit/Participant

This is to Certify that **RAJ KUMAR . M**.....Son/daughter
 of.....**MURUGAN**.....Date of Birth **09./02/2000**
 from School/~~State~~/Academy/Organization/College
**TAMILNADU**.....

Participated in **National Championship** which was held on
 26th to 28th November 2021 at

SDAI...STADIUM...TIRUPPUR...TAMILNADU.....

He/she got ...**SECOND**.....Place in **KABADDI**.....Game
Event in **UNDER-21**.....Age Category.



Original Certificate Identity

Mr. M. Poovarasan
Tamilnadu SDAI/ President

Mr. Shivam Thakur
National Member/ President

Mr. Ankit Kumar
Vice-President



TAFISA



ICSSPE



International Association for
Sports and Leisure Facilities

Sr. No.



School Games & Activity Development Foundation



Register Under: Indian Govt. Trust Act, NITI Aayog Govt. of India, MSME- Ministry of Micro Small & Medium Enterprises, Fit India & Nehru Yuva Kendra Sangathan

Affiliated with International Council for Sports and Activity Federation

Membership By International : ICSSPE-IAKS-TAFISA

Organization Certified By : International Organization Standardization ISO 9001 : 2015

IAKS Partner of : PSN, International Paralympic Committee, German Sports University

ICSSPE Partner of : International Federation of Sports Medicine, International Olympic Committee

FIT INDIA & NYKS Recognised Under

MINISTRY OF YOUTH AFFAIRS AND SPORTS GOVERNMENT OF INDIA

NATIONAL CHAMPIONSHIP

Certificate of Merit/Participant

This is to Certify that...**SURYA...R**.....Son/daughter of...**RAJENDRAN**.....Date of Birth **22/01/2004** from School/State/Academy/Organization/College**TAMILNADU**.....

Participated in **National Championship** which was held on 26th to 28th November 2021 at

...**SDAT...STADIUM...TIRUPPUR...TAMILNADU**.....

He/she got ...**SECOND**.....Place in..**KABADDI**.....GameEvent in..**UNDER...19**.....Age Category.



M. Poovarasan
Mr. M. Poovarasan
Tamilnadu SOADF/ President

Shivam Thakur
Mr. Shivam Thakur
National Member/ President

Ankit Kumar
Mr. Ankit Kumar
Vice President



TAFISA



ICSSPE



International Association for Sports and Leisure Facilities



Sr. No.



School Games & Activity Development Foundation

Register Under: Indian Govt. Trust Act, NITI Aayog Govt. of India,
 MSME- Ministry of Micro Small & Medium Enterprises,
 Fit India & Nehru Yuv Bharo Sangathan
 Affiliated with: International Council for Sports and Activity Federation
 Membership By International : **ICSSPE-IAKS-TAFISA**
 Organization Certified By : International Organization Standardization ISO 9001: 2015
 IAKS Partner of : IFSA, International Paralympic Committee, German Sports University
 ICSSPE Partner of : International Federation of Sports Medicine, International Olympic Committee

FIT INDIA & NYKS Recognised Under

MINISTRY OF YOUTH AFFAIRS AND SPORTS GOVERNMENT OF INDIA

NATIONAL CHAMPIONSHIP

Certificate of Merit/Participant

This is to Certify that **RAJADURA.J...** Son/daughter
 of **JAYAMUTHU.KUMAR** Date of Birth **28./12./2002**

from School/State/Academy/Organization/College

TAMILNADU

Participated in **National Championship** which was held on
 26th to 28th November 2021 at

SRAST...STADIUM...TIRUPPUR...TAMILNADU

He/she got **SECOND** Place in **KABADDI** Game

Event in **UNDER...19** Age Category.



M. Poovarasan
 Mr. M. Poovarasan
 Tamilnadu SGADF President

Shivam Thakur
 Mr. Shivam Thakur
 National Member President

Ankit Kumar
 Mr. Ankit Kumar
 Vice President



TAFISA



ICSSPE



International Association for Sports and Culture Activities



Sr. No.



School Games & Activity Development Foundation

Register Under: Indian Govt. Trust Act, NITI Aayog Govt. of India,
MSME- Ministry of Micro Small & Medium Enterprises,
Fit India & Nehru Yuva Kendra Sangathan
Affiliated with International Council for Sports and Activity Federation
Membership By International : **ICSSPE-IAKS-TAFISA**
Organization Certified By : International Organization Standardization ISO 9001: 2015
IAKS Partner of : FIS, International Paralympic Committee, German Sports University
ICSSPE Partner of : International Federation of Sports Medicine, International Olympic Committee



FIT INDIA & NYKS Recognised Under

MINISTRY OF YOUTH AFFAIRS AND SPORTS GOVERNMENT OF INDIA

NATIONAL CHAMPIONSHIP

Certificate of Merit/Participant

This is to Certify that..**SURYA..R**.....Son/daughter
of.....**RAMUNATH**.....Date of Birth **17../.02../.1999**

from School/State/Academy/Organization/College

.....**TAMIL NADU**.....

Participated in **National Championship** which was held on
26th to 28th November 2021 at

SDAT...STADIUM,....TIRUPPUR,....TAMIL NADU.....

He/she got**SECOND**.....Place in..**KABADDI**.....Game

.....Event in**UNDER..22**.....Age Category.



Original Certificate Seal

Mr. M. Poovarasan
Secretary SQAOP President

Mr. Shivam Thakur
National Member President

Mr. Ankit Kumar
Vice President



TAFISA



ICSSPE



International Association for
Sports and Leisure Facilities

Sr. No.



School Games & Activity Development Foundation

Register Under: Indian Govt. Trust Act, NITI Aayog Govt. of India,
MSME - Ministry of Micro Small & Medium Enterprises,
Fit India & Nehru Yous Kendra Sangathan
Affiliated with: International Council for Sports and Activity Federation
Membership By International : **ICSSPE-IAKS-TAFISA**
Organization Certified by : International Organization Standardization ISO 9001: 2015
IAKS Partner of : FSN, International Paralympic Committee, German Sports University
ICSSPE Partner of : International Federation of Sports Medicine, International Olympic Committee



FIT INDIA & NYKS Recognised Under

MINISTRY OF YOUTH AFFAIRS AND SPORTS GOVERNMENT OF INDIA

NATIONAL CHAMPIONSHIP

Certificate of Merit/Participant

This is to Certify that **VIGNESH WARAN...P.....** Son/daughter
of **...PALANIRAJ.....** Date of Birth **..08./01../2003**

from School/State/Academy/Organization/College

.....TAMILNADU.....

Participated in **National Championship** which was held on
26th to 28th November 2021 at

...SDAT...STADIUM...TIRUPPUR...TAMILNADU.....

He/she got **....SECOND.....** Place in **KABADDI.....** Game

.....Event in UNDER:-19..... Age Category.



Mr. M. Poovarasari
Mr. M. Poovarasari
Tamilnadu SGADF President

Mr. Shivam Thakur
Mr. Shivam Thakur
National Member President

Mr. Ankit Kumar
Mr. Ankit Kumar
Vice-President



TAFISA



ICSSPE



International Association for
Sports and Leisure Facilities

Sr. No.



School Games & Activity Development Foundation

Register Under Indian Govt. Trust Act, NITI Aayog Govt. of India,
MSME- Ministry of Micro Small & Medium Enterprises,
Fit India & Nehru Yuva Kendra Sangathan

Affiliated with: International Council for Sports and Activity Federation
Membership By International : **ICSSPE-IAKS-TAFISA**

Organization Certified By : International Organization Standardization ISO 9001: 2015
IAKS Partner of : IFSN, International Paralympic Committee, German Sports University
ICSSPE Partner of : International Federation of Sports Medicine, International Olympic Committee



FIT INDIA & NYKS Recognised Under

MINISTRY OF YOUTH AFFAIRS AND SPORTS GOVERNMENT OF INDIA

NATIONAL CHAMPIONSHIP

Certificate of Merit/Participant

This is to Certify that... **ALEX.T** Son/daughter
of.....**THANIMARAJ**..... Date of Birth **04/10/2003**
from School/~~State~~/Academy/Organization/College
.....**TAMIL NADU**.....
Participated in **National Championship** which was held on
26th to 28th November 2021 at
...**S.D.A.T. STADIUM, TIRUPPUR, TAMIL NADU**.....
He/she got ...**SECOND**..... Place in...**KABADDI**..... Game
.....Event in **UNDER-19**..... Age Category.



Original Certificate
MSAF

M. Poovarasan

Mr. M. Poovarasan
Tamilnadu SOAOFI President

Shivam Thakur

Mr. Shivam Thakur
National Member/ President

Ankit Kumar

Mr. Ankit Kumar
Vice-President



TAFISA



ICSSPE



International Association for
Sports and Leisure Facilities

Sr. No.



School Games & Activity Development Foundation



Register Under: Indian Govt. Trust Act, With Ayayam Govt. of India,
 MSME: Ministry of Micro Small & Medium Enterprises,
 Fit India & Nehru Yuva Kendra Sangathan
 Affiliated with: International Council for Sports and Activity Federation
 Membership By International : ICSSPE IAKS-TAFISA
 Organization Certified By : International Organization Standardization ISO 9001: 2015
 IAKS Partner of : ISM, International Paralympic Committee, German Sports University
 ICSSPE Partner of : International Federation of Sports Medicine, International Olympic Committee
FIT INDIA & NYKS Recognised Under

MINISTRY OF YOUTH AFFAIRS AND SPORTS GOVERNMENT OF INDIA

NATIONAL CHAMPIONSHIP

Certificate of Merit/Participant

This is to Certify that **NAKARJUN..A**.....Son/daughter
 of...**ANMAMUTHU**.....Date of Birth **24 / 07 / 1999**

from School/State/Academy/Organization/College

.....**TAMIL NADU**.....

Participated in **National Championship** which was held on
 26th to 28th November 2021 at

S.D.A.T.....STADIUM..TIRUPPUR..TAMILNADU.....

He/she got**SECOND**.....Place in **KABADDI**.....Game

.....Event in **UNDER...22**....Age Category,



Original Certificate
Issued by

Mr. M. Poovarasan
Tamilnadu SGADF President

Mr. Shivam Thakur
National Meritist President

Mr. Ankit Kumar
Usp-President



TAFISA



ICSSPE



International Association for
Sports and Leisure Facilities



Income Tax Department, Tirupur

CERTIFICATE OF APPRECIATION

This Certificate is presented to A. ELAYARASU of CHIKKANNA GOVT ARTS COLLEGE, TIRUPUR for participating in the ESSAY WRITING competition on the occasion of Azadi ka Amrit Mahotsav on the theme:

"Independence @ 75 Self-Reliance with Integrity"

"स्वतंत्र भारत @ 75 आत्मनिर्भरता के साथ अमृत महोत्सव"

आजादी का
अमृत महोत्सव
and she has been adjudged to **FIRST PRIZE**

Presented on the Day 09th of DECEMBER 2021

Adil. Commissioner of Income Tax
Tirupur



Income Tax Department, Tirupur

CERTIFICATE OF APPRECIATION

This Certificate is presented to DHANUS KUMAR T of CHIKKANNA GOVT ARTS COLLEGE, TIRUPUR for participating in the DRAWING competition on the occasion of Azadi ka Amrit Mahotsav on the theme:

"Freedom of Thought"

"सोच की आजादी"

आजादी का
अमृत महोत्सव
and he has been adjudged to **CONSOLATION PRIZE**

Presented on the Day 09th of DECEMBER 2021

Adil. Commissioner of Income Tax
Tirupur



மாநில சிறுபான்மையினர் ஆணையம்
தமிழ்நாடு அரசு

அனைத்துக் கல்லூரி மாணவர்களுக்கான
பேச்சுப் போட்டிகள் - 2022

சான்றிதழ்

மாநில சிறுபான்மையினர் ஆணையம், தமிழ்நாடு அரசு நடத்திய 2022ஆம் ஆண்டிற்கான
கல்லூரி மாணவர்களுக்கான பேச்சு போட்டியில் திருப்பூர், சீக்கண்டா அரசுக் கலை கல்லூரியி-
திருவாளர் சீ. சி. தனுஷ் அவர்கள் பங்கேற்று சிறப்பித்ததை பாராட்டி வழங்கப்பட்ட

திகதி: 04.04.2022

ஒழுங்கினைப்பாளர்கள்

மாணவர்கள் பிரிவு அலுவலர் அலுவலர் திருப்பூர்

மாணவர்கள் பிரிவு அலுவலர் திருப்பூர்

மாணவர்கள் பிரிவு அலுவலர் திருப்பூர்



(Handwritten signature)

மாணவர்கள் பிரிவு அலுவலர் திருப்பூர்

தலைவர்

தமிழ்நாடு சிறுபான்மையினர்



In the day of 25-03-2022 , Coimbatore Zone Inter-College Level Essay and Drawing competitions were conducted in our college. M. Kavinkumar received First place in drawing and R. Bharathkumar received second place in essay writing competition.







தமிழாய்வுத்துறை
தூய வளனார் கல்லூரி (தூயவளம்)
(தூயவளம் கல்லூரி, தூயவளம் கல்லூரி, தூயவளம் கல்லூரி)
திருச்சிராப்பள்ளி - 620 002



முத்தமிழ் விழா-2022

திருச்சிராப்பள்ளி தூய வளனார் கல்லூரி தமிழாய்வுத்துறையில்
 வி. ஜி. சந்தேசம் மற்றும் முனைவர் அ. குமுந்தைசாமி
 அறுக்கட்டளைகளின் சார்பாக 22-05-2022 அன்று நடைபெற்ற

முத்தமிழ் விழாப் போட்டியில்

திருமிகு ம. கவிவிடுமார், டிராக்டர் குமார்
 கிராமம் சூனிய, சிங்கைணா அரங்கம் கலை
 கலை, திரைப்படம்
 கிண்டல்சாட்டியில் பங்கேற்று வென்றார்

பெற்றுள்ளார் என்பதைப் பாராட்டி இச்சான்றிதழ்
 வழங்கப்பெறுகிறது.



முனைவர் ம. அருணாச்சலம் சேஷியர், செ.ச. முனைவர் கு.வ.சுப்பிரமணியன்



FORM - 3

S.No. 3113

(For representing a University in the inter - University competition of the recognized games / sports)



BHARATHIAR UNIVERSITY - COIMBATORE - 641 046

Certificate to a meritorious BOXING

Sportsman for employment to a Class III Service under Central Government.

Certified that Shri K. JAGATHRATCHAGAN Son / Daughter
of Shri S. KARTHIKEYAN resident of 2/42, INDIRA NAGAR,
ANGERIPALAYAM, TIRUPUR
student of CHIKKANNA GOVERNMENT ARTS COLLEGE, TIRUPUR
represented the **Bharathiar University** in the Game / Event of BOXING
Participated in the South Zone / All India Inter University Tournament / Athletic Meet / held
at JALANDHAR, PUNJAB Organized by the LOVELY PROFESSIONAL
UNIVERSITY, JALANDHAR, PUNJAB for the year 2021-2022
from 26.12.2021 to 01.01.2022

The Position obtained by the individual / team in the above said competition - tournament was.....

The Certificate is being given on the basis of records available in the office of the Director of Physical Education in the **BHARATHIAR UNIVERSITY**.

Place : Coimbatore

Signature : [Signature] 10.02.2022

Date : 10.02.2022

Name : S.T.N. RAJESWARAN

Name of the University and Address :

Designation : Director of Physical Education in
Bharathiar University,
Coimbatore - 641 046.

Seal :



BHARATHIAR UNIVERSITY
COIMBATORE- 641 046.
TAMILNADU

Note : This Certificate will be valid only when Signed personally by the Registrar / Dean / Director of Physical Education or other officer in overall charges of sports in the **Bharathiar University**.

FORM - 3

S.No. 3239

(For representing a University in the inter - University competition of the recognized games / sports)



BHARATHIAR UNIVERSITY - COIMBATORE - 641 046

Certificate to a meritorious

HOCKEY

Sportsman for employment to a Class III Service under Central Government.

Certified that Shri S. AGATHIYAN Son / Daughter

of Shri A. SATHASIVAM resident of 2/22, ANNA NAGAR,

4th STREET, PUNJAI PULIAMPATTI, SATHY, ERODE, TAMILNADU

student of CHIKKANNA GOVERNMENT ARTS COLLEGE, TIRUPPUR

represented the **Bharathiar University** in the Game / Event of HOCKEY

Participated in the South Zone / All India Inter University Tournament / Athletic Meet / held

at BANGALORE, KARNATAKA Organized by the BANGALORE UNIVERSITY,

BANGALORE, KARNATAKA for the year 2021 - 2022

from 27.12.2021 to 31.12.2021

The Position obtained by the individual / team in the above said competition - tournament was NIL

The Certificate is being given on the basis of records available in the office of the Director of Physical Education in the **BHARATHIAR UNIVERSITY.**

Place : Coimbatore

Signature : S.T.N. RAJESWARAN 05.07.2022

Date: 05.07.2022

Name : S.T.N. RAJESWARAN

Name of the University and Address :

Designation : Director of Physical Education i/c
Bharathiar University,
Coimbatore - 641 046.

Seal :



**BHARATHIAR UNIVERSITY
COIMBATORE- 641 046.
TAMILNADU**

Note : This Certificate will be valid only when Signed personally by the Registrar / Dean / Director of Physical Education or other officer in overall charges of sports in the **Bharathiar University.**

S.No. 3238

FORM - 3

(For representing a University in the inter - University competition of the recognized games / sports)



BHARATHIAR UNIVERSITY - COIMBATORE - 641 046



Certificate to a meritorious.....

HOCKEY

Sportsman for employment to a Class III Service under Central Government.

Certified that Shri.....

S. HALABAYAN

Son / Daughter

of Shri.....

S. SHANMUGAM

resident of

12/19, ANNA NAGER,

4th STREET,

DINJAI PULLAMPATTI, SAKTHY, ERODE, TAMILNADU

student of.....

CHIKKANNA GOVERNMENT ARTS COLLEGE, TIRUPPUR

represented the Bharathiar University in the Game / Event of.....

HOCKEY

Participated in the South Zone / All-India Inter University Tournament / Athletic Meet / held

at BANGALORE, KARNATAKA

Organized by the

BANGALORE UNIVERSITY,

BANGALORE, KARNATAKA

for the year 2021 - 2022

from 27.12.2021

to 31.12.2021

The Position obtained by the individual / team in the above said competition - tournament was.....

- Nil -

The Certificate is being given on the basis of records available in the office of the Director of Physical Education in the **BHARATHIAR UNIVERSITY**.

Place : Coimbatore

Signature :

S. T. N. RAJESWARAN 05.07.2022

Date : 05.07.2022

Name :

S. T. N. RAJESWARAN

Name of the University and Address :

Designation :

Director of Physical Education,
Bharathiar University,
Coimbatore - 641 046.

Seal :



BHARATHIAR UNIVERSITY
COIMBATORE- 641 046.
TAMILNADU

Note : This Certificate will be valid only when Signed personally by the Registrar / Dean / Director of Physical Education or other officer in overall charges of sports in the **Bharathiar University**.

WSSDF 1st NATIONAL ALL GAMES CHAMPIONSHIP - 2021
STUDENTS SPORTS DEVELOPMENT ASSOCIATION OF INDIA



Affiliated by: WORLD STUDENTS SPORTS DEVELOPMENT FEDERATION

Member of Ministry of youth affair and Sports Government of India
 Member of Fit India | Member of Central Vigilance Commission
 Member of National Commission for Women India | Member of National Human Rights Commission India
 Member of MSME | Member of National Commission for Women | Member of Ministry of electronics and information technology
 Member of Ministry of skill development and Entrepreneurship

Certificate Of Merit

Certificate No.: **000001** Aadhaar No : **4770 7212 5022**
 This is to certify that : **K. JAGATHIRATCHAGAN** D/o. S/o, W/o: **KARTHIKEYAN**
 Representing **TAMILNADU** Date of Birth **15.10.2002** Participate as a player / Coach / Official /
 Team Managers/Volunteer's in the WSSDF 1st National All Games Championship - 2021. Held on: **18.09.2021**
 Age Category **U-19** Weight Category **46-48** Game **BOXING**

Venue: **LALITHA MEMORIAL JUNIOR COLLEGE, Thamma Pudi-522330, Duggirala Mandal, Guntur District, Andhra Pradesh.**

Position: **First / Second / Third / Fourth / Participation**
 Organized by: **Students Sports Development Association of India.**



K. Shanmuga J. Jiji
 Chairman
 Students Sports Development
 Association of India

Siva Karthikeyan Jijith
 President
 Students Sports Development
 Association of India

Bhavarath Hanu Kabilakrishna
 President
 Students Sports Development
 Association of Andhra Pradesh

Venkat Ananthakrishna
 Managing Secretary
 Students Sports Development
 Association of Andhra Pradesh

BHARATHIAR UNIVERSITY

COIMBATORE - 641 046.

C.No. 913

INTER-COLLEGIATE TOURNAMENTS

2021 - 2022

CERTIFICATE OF MERIT

Name : **S.T. KALAIYANI**
 Institution : **CHIKKANNA ARTS COLLEGE**
 Degree : **Bcom (I.B)** Year: **II** Date of Birth **16-10-2002**
 Event : **BOXING (92kg)**
 Place : **THIRD**
 Performance : **-** Date: **07-12-2021**

S. Srinivas
 Director of Physical Education i/c.

B. Venkatesh
 Vice-Chancellor

BHARATHIAR UNIVERSITY
 COIMBATORE - 641 046. C.No. 589

INTER-COLLEGIATE TOURNAMENTS
 2021 - 2022

CERTIFICATE OF MERIT

Name : S. AGATHIYAN
 Institution : CHIKKANNA GOVERNMENT ARTS COLLEGE
 Degree : _____ Year _____ Date of Birth _____
 Event : HOCKEY
 Place : IV PLACE
 Performance : _____ Date : 18.12.2021

[Signature]
 Director of Physical Education i/c

[Signature]

BHARATHIAR UNIVERSITY
 COIMBATORE - 641 046. C.No. 589

INTER-COLLEGIATE TOURNAMENTS
 2021 - 2022

CERTIFICATE OF MERIT

Name : S. DHANUSH
 Institution : CHIKKANNA GOVERNMENT ARTS COLLEGE
 Degree : BBA Year II Date of Birth _____
 Event : HOCKEY
 Place : IV PLACE
 Performance : _____ Date : 18.12.2021

[Signature]
 Director of Physical Education i/c

[Signature]
 Vice - Chancellor

BHARATHIAR UNIVERSITY
COIMBATORE - 641 046. C.No. 577

INTER-COLLEGIATE TOURNAMENTS
2021 - 2022
CERTIFICATE OF MERIT

Name : S. JEEVA
Institution : CHIKKANNA GOVERNMENT ARTS COLLEGE
Degree : BA. (ECONOMICS) Year : I Date of Birth : _____
Event : HOCKEY
Place : IV PLACE
Performance : _____ Date : 18.12.2021

K. Srinivasan
Director of Physical Education i/c

B. Lakshmi
Vice-Chancellor

BHARATHIAR UNIVERSITY
COIMBATORE - 641 046. C.No. 581

INTER-COLLEGIATE TOURNAMENTS
2021 - 2022
CERTIFICATE OF MERIT

Name : V. SELVAKUMAR
Institution : CHIKKANNA GOVERNMENT ARTS COLLEGE
Degree : B.Sc (PHYSICS) Year : III Date of Birth : _____
Event : HOCKEY
Place : IV PLACE
Performance : _____ Date : 18.12.2021

K. Srinivasan
Director of Physical Education i/c

B. Lakshmi
Vice-Chancellor

BHARATHIAR UNIVERSITY



COIMBATORE - 641 046.

C.No. 901

INTER-COLLEGIATE TOURNAMENTS

2021 - 2022

CERTIFICATE OF MERIT

Name : K. JAGATH RATCHGAN
Institution : CHIRANNA COLLEGE
Degree : _____ Year: _____ Date of Birth: _____
Event : BOXING (48 kg)
Place : FIRST
Performance : _____ Date: 08-12-2021

[Signature]
Director of Physical Education i/c.

[Signature]
Vice-Chancellor

2020-21

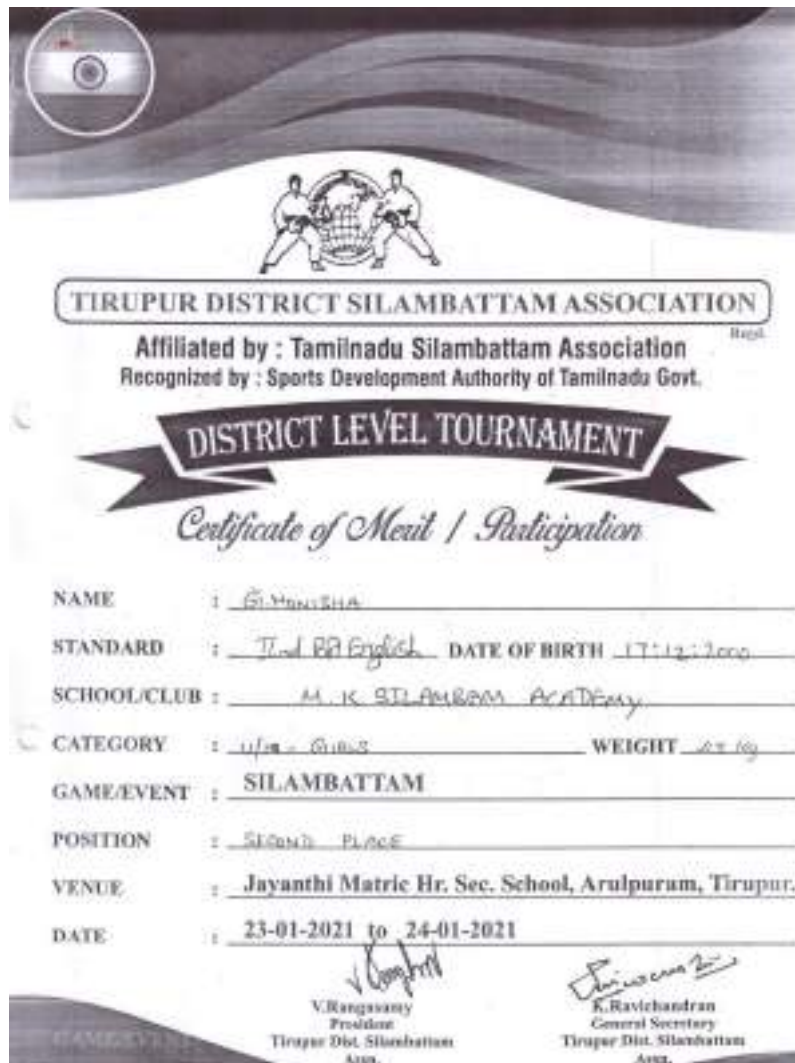
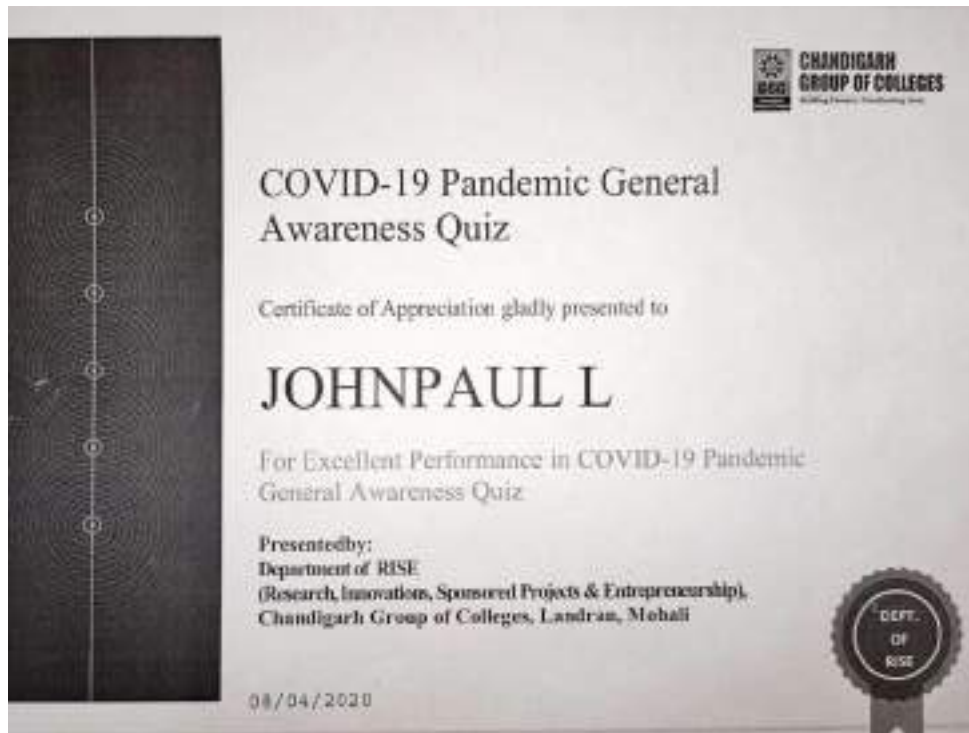



CHIKKANNA GOVERNMENT ARTS COLLEGE :: TIRUPUR

(Affiliated to Bharathiar University, Coimbatore and Re-Accredited by NAAC with 'B' Grade)

TAMIL NADU, INDIA



CERTIFICATE OF APPRECIATION

This is to certify that **Dharani S**, M.A. English Literature
from Chikkanna Government Arts College has taken up the online **"LITERARY QUIZ"**
conducted by the Department of English, Chikkanna Government Arts College, Tirupur and
secured 64%

WMX0LC-CE000014

6/6/2020



Arignar Anna Govt. Arts College

Postal: arignar@anna.govt.ac.in Nationally Accredited at 'B' grade by NAAC

DEPARTMENT OF ENGLISH

E-QUIZ ON ENGLISH GRAMMAR

CERTIFICATE OF APPRECIATION

This Certificate is awarded to

Ragul

BCA

CHIKKANNA GOVERNMENT ARTS COLLEGE

*For active participation in E-QUIZ ON ENGLISH GRAMMAR organized by DEPARTMENT OF ENGLISH
during Covid- 19 Quarantine period and his/her Score is 40%.*

5/20/2020

B.K. Mayagonda
Quiz Co-Ordinator

S. Gnanaprakasam
Quiz Co-Ordinator

Dr. K. Meenatchi
HOD

Dr. N. Vyasaratnam
Principal

OGSPIU-CE000056

GOVERNMENT ARTS AND SCIENCE COLLEGE FOR WOMEN
KARIMANGALAM-635 111, DHARMAPURI DISTRICT
ONLINE QUIZ ON BASIC'S OF COMPUTER

CERTIFICATE



This is to Certify that Dr/Mr/Miss/Ms. S. Ragul has participated in the ONLINE QUIZ ON BASIC'S OF COMPUTER Department of Computer Application, Govt. Arts and Science College for Women, Karimangalam-635 111, Dharmapuri.

CONVENOR

R.RAMESH
Assistant Professor
Department of Computer Applications

**ORGANIZED SECRETARY
PRINCIPAL**

Government Arts and Science College for Women
Karimangalam-635 111



TIRUPUR DISTRICT AMATEUR BODY BUILDING ASSOCIATION

Affiliated with & Recognized by:
Indian Body Building & Fitness Federation
Ministry of Youth Affairs & Sports Govt. of India,
Sports Authority of India & Indian Olympic Association

**Mr. ANYTIME CLASSIC
DISTRICT LEVEL
BODY BUILDING CHAMPIONSHIP**

CERTIFICATE OF MERIT

This is to Certify that Mr. E. SANTEEV of
EVEREST INDIAN Gym has Secured SECOND Place in 55 Kg
Category in Tirupur District Level Senior Body Building Championship 2021. Held at
VELLIANGADU 60FEET ROAD, OPP, DEVI SHCOOL, Tirupur on 14-03-2021

Organizer

President
TDABBA

G. M. V.
Chief Judge
TDABBA

S. S.
Secretary
TDABBA

B3

B3



TIRUPUR DISTRICT AMATEUR BODY BUILDING ASSOCIATION

Affiliated with & Recognized by
Indian Body Building & Fitness Federation
Ministry of Youth Affairs & Sports Govt. of India,
Sports Authority of India & Indian Olympic Association

Mr. TIRUPUR - 2021 BODY BUILDING CHAMPIONSHIP

Organized by
TIRUPUR DISTRICT AMATEUR BODY BUILDING ASSOCIATION
CERTIFICATE OF MERIT

This is to Certify that Mr. E. SANJEEV of
..... Gym has Secured Third Place in 65 Kg

Category in Tirupur District Level Senior / Master / Men's Physique Body Building Championship 2021

Held at Tirupur South Rotary Club Hall, Tirupur on 06.03.2021

President
TDABBA

Chief Judge
TDABBA

Secretary
TDABBA



THE WORLD COMMUNITY SERVICE CENTRE

SPIRITUAL WORLD RECORD

CERTIFICATE

OF PARTICIPATION

This Certificate is Presented to SURESHKUMAR M

for participating in the "Spiritual World Record 2021"

Cert No: SWR-IT-12990

Date - 28 March 2021



SIGNATURE
PRESIDENT, WCSC



THE WORLD COMMUNITY SERVICE CENTRE

SPIRITUAL WORLD RECORD

CERTIFICATE

OF PARTICIPATION

This Certificate is Presented to ARULKUMAR

for participating in the "Spiritual World Record 2021"

Cert No: *SWR-IT-75172*

Date - 28 March 2021



Sb M. Haalish
SIGNATURE
PRESIDENT, WCSC



THE WORLD COMMUNITY SERVICE CENTRE

SPIRITUAL WORLD RECORD

CERTIFICATE

OF PARTICIPATION

This Certificate is Presented to AKILPRASATH.R

for participating in the "Spiritual World Record 2021"

Cert No: *SWR-IT-12990*

Date - 28 March 2021



Sb M. Haalish
SIGNATURE
PRESIDENT, WCSC



2020-21

Ek Bharath Shreshtha Bharath

NATIONAL INTEGRATION CAMP FOR WOMEN

22-28, March 2021

Organized by

Government of India - Ministry of Youth Affairs & Sports
Government of Karnataka - Department of Youth Empowerment & Sports
Regional Directorate of NSS, Bengaluru

And

**National Service Scheme Cell
Karnataka State Akkamahadevi Women's University**

Manakoti Campus, Tirvi, Vijayapura, Karnataka, India - 586108

Participation Certificate

This is to certify that Keerthana. M from Bharathiar University, Coimbatore, TN has Participated in National Integration Camp for Women Organized by National Service Scheme - Karnataka State Akkamahadevi, Women's University, Vijayapura, Karnataka from 22nd to 28th March 2021.

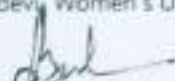
Prof. Namadev M. Gouda
Programme Coordinator - NSS
KSRWU, Vijayapura

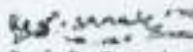
Prof. R. Sunandamma
Registrar
KSRWU, Vijayapura

Prof. B. K. Tulasimala
Vice - Chancellor
KSRWU, Vijayapura

2019-20

NABBA / WFF INDIA
INDIA CUP - 2019
NATIONAL PRO-AM CHAMPIONSHIP - BODYBUILDING & FITNESS
ORGANISED BY
INDIAN FITNESS FEDERATION / TAMILNADU

Merit Certificate

This is to Certify that Sri S. DHANISH KUMAR of TAMILNADU
has participated in the 1st edition of MR & MS. INDIA CUP® 2019 - NATIONAL PRO-AM CHAMPIONSHIP
(BODYBUILDING & FITNESS), held at NGI Coimbatore on 27th & 28th April 2019 and Secured
7 place in MEN RERMUDAS HOTEL 172 40 179 Category.
We wish him / her all success in future endeavour.

DHIRAJ MOHAN DAS
President, NABBA / WFF INDIA

E.VEEMURUGAN
President, NABBA / WFF TAMILNADU &
SOUTH INDIA
www.nabbawffindia.com

S.JEGANATHAN
WFF SECRETARY

INDIAN FITNESS FEDERATION
4852, Nallajin Street, Marudai Park, Sarathi Colony, Coimbatore - 64, Contact : 9889 8374, 9-4447, jegan@iffindia.com

MR. USC 2019
OPEN STATE LEVEL BODYBUILDING & FITNESS CHAMPION

ORGANISED BY

Merit Certificate

This is to Certify that Sri S. DHANISH KUMAR of TIRUPUR
has participated in the MR. ULTIMATE SUPER CHAMPION - 2019, OPEN STATE LEVEL BODYBUILDING and
FITNESS CHAMPION, held at Purandaradasar Auditorium, R.S Puram, Coimbatore on 23rd June 2019 and
Secured 6th place in OPEN Category.

S.S.VISHNU
President - IFF

S.JEGANATHAN
Founder and General Secretary - IFF

R.DHANASEKARAN
Treasurer - IFF

Website: www.iffindia.com

BHARATHIAR UNIVERSITY

COIMBATORE - 641 046.

C.No. 1420

INTER-COLLEGIATE TOURNAMENTS

2019 - 2020

CERTIFICATE OF MERIT

Name : DHANUSHKUMAR. S
Institution : CHIKKANNA GOVT ARTS COLLEGE
Degree : B.Sc [CHEMISTRY] Year : III Date of Birth 03-07-2000
Event : BEST PHYSIQUE - 75 Kg
Place : SECOND
Performance : - Date : 01-10-2019

Director of Physical Education i/c.

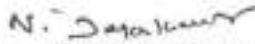
Vice-Chancellor Committee

BHARATHIAR UNIVERSITY

COIMBATORE - 641 046

C.No. 2060

INTER-COLLEGIATE TOURNAMENTS

2019 - 2020

CERTIFICATE OF MERIT

Name : N. JANSIRANI
Institution : CHIKKANNA GOVT ARTS COLLEGE TIRUPPUR
Degree : B.Sc CHEMISTRY Year : I
Event : Taekwondo
Place : Silver
Performance : - Date : 08.01.2020

Professor and Director.

Vice-Chancellor.



TIRUPUR DISTRICT CHESS ASSOCIATION

(Affiliated to TNSCA, Chennai)



Participation Certificate

for

OPEN & AGE CATEGORY CHESS CHAMPION-2020

[Tirupur District Championship Selection Match]

This is to certify that Selvan/Selvi A. Mohamed Ibrahim

School Cga College

participated in the tournament in Category U-19 and was

placed 5th and scored 1.5 points from 5 rounds.

Date : 12.01.2020

Venue : Kamatchi Amman Kalyana Mandapam, Tirupur.

K.P.K. Selvaraj

K.P.K.SELVARAJ
President
Tirupur District
Chess Association

T.R. Sivan

T.R.SIVAN
Secretary
Tirupur District
Chess Association

V.P. Manokaran

V.P.MANOKARAN
Joint Secretary
Tirupur District
Chess Association

R. Rajendran

R.RAJENDRAN
Chief Arbiter
Treasurer, Tirupur District
Chess Association



ASSOCIATED WITH



INDIAN RINK FOOTBALL LEAGUE

Sr No: _____

Certificate of Participation

This is to certify that Mr/Ms Pratima Bharti
 of U-18 category from Chennai team
 has participated as Player/Coach/Official at Indian Rink Football League Season 2
 held at Meenatai Thackeray Indoor Stadium, Nashik from 31st Jan - 2nd Feb 2020
 organized by Indian Rink Football Federation in association with Rink Football Pvt Ltd
 recognised by Asian Rink Football Confederation under the aegis of
 World Rink Football Federation

MS. PRATIMA BHARTI
SECRETARY GENERAL
INDIAN RINK FOOTBALL FEDERATION

MR. ANIKET KESARKAR
SECRETARY GENERAL
WORLD RINK FOOTBALL FEDERATION





B.D.F.I

BOXING DEVELOPMENT FEDERATION OF INDIA

CERTIFICATE OF MERIT



SANDEEP MALIK
BOXING CLUB

This is to certify that Ms. NARENDRA N . K
 D/o, S/o, W/o KARTHIGEYAN . S
 born on 26.11.2000
 representing TAMILNADU
3rd All India Men's National Boxing Championships
 Organised by HARYANA State/UT/Board Boxing Association
 Held at Solan, Haryana From 16-12-2019 to 20-12-2019
 has won the SILVER medal
 in the LIGHT WELTER (60-64 kg) weight category.



Anil Kumar
President
Boxing Development Federation Of India

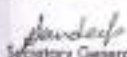

Sandeep
Secretary General
Boxing Development Federation Of India

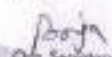

Raju
Org. Secretary



508

Regd. No. DL/DE/S/3096/2019

SR. NO.: YGFI/19/YGANCI/569



Youth Games Federation

Approved By : The Association for International Sports for All-TAFISA
Tafisa Recognized by International Olympic Committee - IOC, WHO, ICSSPE & UNESCO



YOUTH GAMES ALL INDIA NATIONAL CHAMPIONSHIP-2019

Official / Participation / Merit Certificate

It is certify that Mr. / Miss K. NARENDRA

Son / Daughter K. KARTHIKEYAN

represented by TAMIL NADU Participation as Player / official

in the Youth Games All India National Championship 2019 and begged Gold / Silver / Bronze

position in the I Event BOXING Category Under 10, 12, 14, 17, 19,

above 19 & Senior Years 60-64 kg weight Category Held at University of Rajasthan, Jaipur

(Rajasthan) on Date 14 Oct., 2019 to 16 Oct., 2019, organized by the Youth Games Association

Rajasthan (YGAR).



Ukumar
SHILAN M. UMESH KUMAR
Hon'ble Founder & Gen. Secretary
Youth Games Federation (INDIA)

jitender
ME JITENDER GURJAR
Hon'ble President
Youth Games Federation (INDIA)

Jhar
ME. BHARMENDER SINGH
Gen. Secretary
Youth Games Association (RAJASTHAN)

Website : <https://www.youthgamesindia.org.in> | <https://www.youthgamesindia.com>



SALEM DISTRICT WRESTLING OPEN MEET 2019

Organised by : Salem District Wrestling Association
Date : 15th & 16th JUNE 2019
Venue : Govt. Boys Higher Secondary School,
Mecheri, Salem Dt.

UNDER 15/ SUB JUNIOR (BOYS / GIRLS) / JUNIOR / UNDER -23 / SENIOR (MENS & WOMENS)

Certificate

Awarded to P. RAMESH

Sir / Din P. PALANISAMY Date of Birth 10.05.1998

U-23 / Under 15/ Junior (Boys / Girls) / Senior (Men & Women) Participation as wrestler /

Official / Referee / Juries Free Style and Greco Roman Style Category 57 (Kg)

Position GOLD



Chairman
Salem District
Wrestling Association

President
Salem District
Wrestling Association

General Secretary
Salem District
Wrestling Association



TAMILNADU AMATEUR WRESTLING ASSOCIATION

**TAMILNADU STATE UNDER - 15; SUB - JUNIOR,
JUNIOR, UNDER 23, SENIOR
WRESTLING TOURNAMENT 2019
(MENS & WOMENS)**

03, 04, 05 - May 2019 @ Gnananthanthal SSM Subramaniam Auditorium,
SSM Institutions, Komarapalayam, Namakkal (Dt),

Certificate

Awarded to P. RAMESH
S/o, D/o, P. PALANI SAMY Date of Birth 10.05.1998
Representing TIRUPPUR District for Under - 15, Sub - Junior
(Boys / Girls), Junior, Under - 23, Senior (Mens / Womens) Participation as
Wrestler / Official / Referee / Juries Free Style / Greco Roman
Style Category 57 F/S (Kg) Position SILVER

G. Murugan
President
Tamilnadu Amateur
Wrestling Association

M. Loganathan
General Secretary
Tamilnadu Amateur
Wrestling Association



TIRUPUR DISTRICT CHESS ASSOCIATION

(Affiliated to TNSCA, Chennai)



Certificate of Merit

for

OPEN & AGE CATEGORY CHESS CHAMPION-2020

[Tirupur District Championship Selection Match]

This is to certify that Selvan/Selvi *T. Vasutidevi*

School *Chikanna Govt Arts College*

participated in the tournament in Category *U-19* and was

placed *II* and scored *2* points from *4* rounds.

Date : 12.01.2020

Venue : Kamatchi Amman Kalyana Mandapam, Tirupur.

K.P.K. Selvaraj

K.P.K.SELVARAJ
President
Tirupur District
Chess Association

T.R. Sivan

T.R.SIVAN
Secretary
Tirupur District
Chess Association

V.P. Manokaran

V.P.MANOKARAN
Joint Secretary
Tirupur District
Chess Association

R. Rajendran

R.RAJENDRAN
Chief Arbitr
Treasurer, Tirupur District
Chess Association

No. 2653

FORM - 3

(For representing a University in the inter - University competition of the recognized games / sports)



BHARATHIAR UNIVERSITY - COIMBATORE - 641 046



Certificate of Meritorious... HOCKEY

Sportsman for employment to a Class III Service under Central Government.

Certified that Shri... S. KAVIYARASU Son / Daughter
of Shri SWASAMI resident of

1/A, KOVIL PUDHUR, SANTHI DAM, ERODE DIST, 638 453
student of CHIKKANA GOVERNMENT ARTS COLLEGE

represented the **Bharathiar University** in the Game / Event of HOCKEY

Participated in the South Zone / All India Inter University Tournament / Athletic Meet / held
at NEW DELHI Organized by the

N.H.S for the year 2018 - 2019
from 24.12.2018 to 02.01.2019

The Position obtained by the individual / team in the above said competition - tournament was S2 - IV
All India - Prof

The Certificate is being given on the basis of records available in the office of the Director of
Physical Education in the **BHARATHIAR UNIVERSITY**.

Place : Coimbatore

Date: 14-09-2019

Name of the University and Address :

Signature: [Signature] 14/9/20

Name : S.T.N. RATISWARAN

Designation : Director of Physical Education
Bharathiar University,
Coimbatore - 641 046.

Seal :



BHARATHIAR UNIVERSITY
COIMBATORE - 641 046.
TAMILNADU

Note : This Certificate will be valid only when Signed personally by the Registrar / Dean / Director of Physical Education or other officer in overall charges of sports in the Bharathiar University.

(With school seal and date)

General series of Blank Certificates for up to 100 X / 100 marks (200 / 200) for use in the Bharathiar University - Coimbatore - 641 046

representing a University in the inter - University competition of the recognized games / sports)



BHARATHIAR UNIVERSITY - COIMBATORE - 641 046

Certificate to a meritorious Hockey

Sportsman for employment to a Class III Service under Central Government.

Certified that Shri. N. KUNJATHANES Son / Daughter

of Shri NAGARAJ resident of B. 183 A, PETHIA KURUBA
PALAYAM, METTUPALAYAM (TK), COIMBATORE (DIST)

student of C.H.K.K.R.M.A. GOVERNMENT ARTS COLLEGE

represented the **Bharathiar University** in the Game / Event of Hockey

Participated in the South Zone / All India Inter University Tournament / Athletic Meet / held

at DELHI Organized by the

NHTS for the year 2018-2019

from 24.12.2018 to 03.01.2019

The Position obtained by the individual / team in the above said competition - tournament was SZ - 12
All India First

The Certificate is being given on the basis of records available in the office of the Director of Physical Education in the **BHARATHIAR UNIVERSITY**.

Place : Coimbatore

Date: 14.09.2019

Name of the University and Address :

Signature: Srinivasan 14/9/2019

Name : S. P. N. RAJESWARAN

Designation : Director of Physical Education in
Bharathiar University,
Coimbatore - 641 046.

Seal :



BHARATHIAR UNIVERSITY
COIMBATORE- 641 046,
TAMILNADU

Note : This Certificate will be valid only when Signed personally by the Registrar / Dean / Director of Physical Education or other officer in overall charges of sports in the **Bharathiar University**.

FORM - 3

S.No. 2633

(For representing a University in the inter - University competition of the recognized games / sports)



BHARATHIAR UNIVERSITY - COIMBATORE - 641 046

BOXING

Sportsman for employment to a Class III Service under Central Government,

Certified that Shri **S. ELANKUMARAN**

Son / Daughter

of Shri **N. SELVAKUMAR** resident of**2/609, 2nd Street, MGB Colony, T. Mannar, Tirupur - 641607**student of **Chikkanna Govt. Arts College**represented the Bharathiar University in the Game / Event of **BOXING**

Participated in the South Zone / All India Inter-University Tournament / Athletic Meet / held

at **RAJASTAN** Organized by the**VIJAYAPETH UNIVERSITY** for the year **2018 - 2019**from **22.02.2019** to **28.02.2019**The Position obtained by the individual / team in the above said competition - tournament was **Nil**The Certificate is being given on the basis of records available in the office of the Director of Physical Education in the **BHARATHIAR UNIVERSITY**;

Place : Coimbatore

Signature :

Date: **08.07.2019**Name : **S.T.N. RAJESWARAN**

Name of the University and Address :

Designation : **Director of Physical Education in
Bharathiar University,
Coimbatore - 641 046.**

Seal :

BHARATHIAR UNIVERSITY
COIMBATORE - 641 046,
TAMILNADU**Note :** This Certificate will be valid only when Signed personally by the Registrar / Dean / Director of Physical Education or other officer in overall charges of sports in the Bharathiar University.

BHARATHIAR UNIVERSITY



COIMBATORE - 641 046.

C.No. 2154

INTER-COLLEGIATE TOURNAMENTS

2018 - 2019

CERTIFICATE OF MERIT

Name : S. DHANUSH KUMAR
Institution : Chikkanna government arts college.
Degree : B.Sc Chemistry Year : _____ Date of Birth 3/7/2000
Event : TAEKWONDO
Place : Second
Performance : U. 68 kg. Date: 07/01/2019

[Signature]
Director of Physical Education i/c.

[Signature]
Vice - Chancellor Committee

BHARATHIAR UNIVERSITY



COIMBATORE - 641 046.

C.No. 0170

INTER-COLLEGIATE TOURNAMENTS

2018 - 2019

CERTIFICATE OF MERIT

Name : S. DHANUSH KUMAR
Institution : CHIKKANNA GOVT ARTS COLLEGE
Degree : BSC CHEMISTRY Year : II Date of Birth 03.07.2000
Event : BEST PHYSIQUE - 70 kg
Place : II
Performance : _____ Date: 10/10/2018

[Signature]
Director of Physical Education i/c.

[Signature]
Vice - Chancellor Committee